



PSD90-3

Universal AC/DC Fuel Quantity Test Set

Operations Manual

Export Control Warning

This document contains technology, the export of which is or may be restricted by the Export Administration Act and the Export Administration Regulations (EAR), 15 C.F.R. parts 730-774. Diversion contrary to U.S. law is prohibited.

PSD90-3

Universal AC/DC Fuel Quantity Test Set

Operation Manual

22166183 R001



VIAVI Solutions
1-844-GO-VIAVI
www.viavisolutions.com

This page intentionally left blank.

Notice

Every effort was made to ensure that the information in this manual was accurate at the time of printing. However, information is subject to change without notice, and VIAVI reserves the right to provide an addendum to this manual with information not available at the time that this manual was created.

Copyright/Trademarks

© Copyright 2023 VIAVI Solutions Inc. All rights reserved. No part of this guide may be reproduced or transmitted, electronically or otherwise, without written permission of the publisher. VIAVI Solutions and the VIAVI logo are trademarks of VIAVI Solutions Inc. (“VIAVI”). All other trademarks and registered trademarks are the property of their respective owners.

Copyright Release

Reproduction and distribution of this guide is authorized for US Government purposes only.

DFARS Statement

If software is for use in the performance of a U.S. Government prime contract or subcontract, software is delivered and licensed as “Commercial Computer Software” as defined in DFAR 252.227-7014 (Feb 2014), or as a “Commercial Item” as defined in FAR 2.101(a) or as “Restricted Computer Software” as defined in FAR 52.227-19 (Dec 2007) or any equivalent agency regulation or contract clause. Use, duplication or disclosure of Software is subject to VIAVI Solutions' standard commercial license terms, and non-DOD Departments and Agencies of the U.S. Government will receive no greater than Restricted Rights as defined in FAR 52.227-19(c)(1-2) (Dec 2007). U.S. Government users will receive no greater than Limited Rights as defined in FAR 52.227-14 (June 1987) or DFAR 252.227-7015 (b)(2) (November 1995), as applicable in any technical data.

Warranty Information

Warranty information for this product is available on the VIAVI website at <https://www.viavisolutions.com/en-us/literature/brochures/avionics-extended-calibration-and-warranty>.

Terms and conditions

Specifications, terms, and conditions are subject to change without notice. The provision of hardware, services, and/or software are subject to VIAVI's standard terms and conditions, available at www.viavisolutions.com/en/terms-and-conditions.

Federal Communications Commission (FCC) Notice

This device complies with part 15 of the FCC Rules. Operation is subject to the following two conditions: (1) This device may not cause harmful interference, and (2) this device must accept any interference received, including interference that may cause undesired operation.

This equipment was tested and found to comply with the limits for a Class A digital device, pursuant to Part 15 of the FCC Rules. These limits are designed to provide reasonable protection against harmful interference when the equipment is operated in a commercial environment. This instrument generates, uses, and can radiate radio frequency energy and, if not installed and used in accordance with the instruction manual, may cause harmful interference to radio communications. Operation of this instrument in a residential area is likely to cause harmful interference, in which case you will be required to correct the interference at your own expense.

The authority to operate this instrument is conditioned by the requirements that no modifications be made to the equipment unless the changes or modifications are expressly approved by VIAVI.

Industry Canada Requirements

This Class A digital apparatus complies with Canadian ICES-003.

Cet appareil numérique de la classe A est conforme à la norme NMB-003 du Canada.

EMC Directive Compliance

This product was tested and conforms to the EMC Directive, 2014/30/EU for electromagnetic compatibility.

Declaration of Conformity

VIAVI recommends keeping a copy of the Declaration of Conformity that shipped with the unit with the device at all times.

Low Voltage Directive Compliance

This product was tested and conforms to the Low Voltage Directive, 2014/35/EU.

EU REACH

Article 33 of EU REACH regulation (EC) No 1907/2006 requires article suppliers to provide information if a listed Substances of Very High Concern (SVHC) is present in an article above a certain threshold. For information on the presence of REACH SVHCs in VIAVI products, see the Hazardous Substance Control section of the VIAVI Standards and Policies web page at:

<https://www.viavisolutions.com/en-us/corporate/legal/policies-standards#sustain> .

WEEE and Battery Directive Compliance

This product, and the batteries used to power the product, should not be disposed of as unsorted municipal waste and should be collected separately and disposed of according to your national regulations.

VIAVI has established a take-back process in compliance with the EU Waste Electrical and Electronic Equipment (WEEE) Directive, 2012/19/EU, and the EU Battery Directive, 2006/66/EC.

Information and instructions for returning waste equipment and batteries to VIAVI can be found on the VIAVI website in the WEEE section of the VIAVI Standards and Policies web page at: <https://www.viavisolutions.com/en-us/corporate/legal/policies-standards#sustain>.

If you have questions concerning the disposal of your equipment batteries, contact the VIAVI WEEE Program Management team at WEEE.EMEA@VIAVISolutions.com

CA Proposition 65

California Proposition 65, officially known as the Safe Drinking Water and Toxic Enforcement Act of 1986, was enacted in November 1986 with the aim of protecting individuals in the state of California and the state's drinking water and environment from excessive exposure to chemicals known to the state to cause cancer, birth defects or other reproductive harm.

VIAVI's position statement on the use of Proposition 65 chemicals in VIAVI products can be found in the Hazardous Substance Control section of the VIAVI Standards and Policies web page at:

<https://www.viavisolutions.com/en-us/corporate/legal/policies-standards#sustain>.

Ordering information

This guide is a product of the VIAVI Technical Publications Department, issued as part of the PSD90-3.

- The material number associated with this manual is 22166183 R001. This manual is available on the VIAVI website in PDF format.

This page intentionally left blank.

Safety and Compliance Information

Symbols and Markings

The following symbols and markings are found on the instrument and in product documentation:

Table 1 Symbols and Markings









	This symbol indicates a note that includes important supplemental information or tips related to the main text.
	Attention Symbol This symbol represents a general hazard. It may be associated with either a DANGER, WARNING, CAUTION, or ALERT message. See Table 2 for more information.
	ESD Sensitive Indicates item is static sensitive. Item should only be handled by Qualified Service Personnel.
	Voltage Symbol This symbol represents hazardous voltages. It may be associated with either a DANGER, WARNING, CAUTION, or ALERT message. See Table 2 for more information.
	Hot Surface Symbol This symbol represents a risk of a hot surface. It may be associated with either a DANGER, WARNING, CAUTION, or ALERT message. See Table 2 for more information.

Table 1 Symbols and Markings

	WEEE Symbol This symbol, located on the equipment, battery, or the packaging indicates that the equipment or battery must not be disposed of in a land-fill site or as municipal waste, and should be disposed of according to your national regulations.
	CE Compliant CE Label indicates item meets the requirements of the applicable European Directives.
	Fuse Symbol Indicates a fuse location (AC or DC).
	Toxic Symbol Indicates a toxic hazard. Item should only be handled by Qualified Service Personnel. Dispose of item in accordance with local regulations.

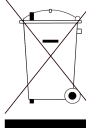
Safety Definitions

This Operation Manual uses the following terms to indicate conditions or activities which are potential safety hazards:

Table 2 Safety Definitions

Term	Definition
CAUTION	Identifies conditions or activities that, if ignored, can result in equipment or property damage, e.g., Fire.
MiseenGarde	Identifiez les conditions ou les activités qui, si ignorées, peuvent entraîner des dommages à l'équipement ou aux biens, p. ex. un incendie.
WARNING	Identifies conditions or activities that, if ignored, can result in personal injury or death.
Avertissement	Identifiez les conditions ou les activités qui, si ignorées, peuvent entraîner des blessures personnelles voire mortelles.

Safety Hazards

Equipment Usage

This device is designed and tested to comply with the requirements of 'IEC/EN 61010-1, 3rd Edition Safety Requirements for Electrical Equipment for Measurement, Control and Laboratory Use' for Class III battery powered device and is for use in a pollution degree 2 environment..



WARNING

Operating this device in a manner not specified in accompanying documentation may impair the safety protection built into the device.

Avertissement

Utiliser cet appareil de manière non spécifiée dans la documentation d'accompagnement peut nuire au dispositif de protection de sécurité intégré dans l'appareil.

Toxic Hazards



WARNING

Some of the components used in this device may include resins and other materials which give off toxic fumes if incinerated. Dispose of such items appropriately.

Avertissement

Certains des composants utilisés dans cet appareil peuvent comprendre des résines et d'autres matériaux qui produisent des émanations toxiques lorsqu'ils sont incinérés. Éliminez adéquatement de tels éléments.

Electrical Hazards

Residual Current



WARNING

The supply filter contains capacitors that may remain charged after the instrument is disconnected from the power supply. The residual energy is within the approved safety requirements, however, a slight shock may be felt if the plug pins are touched immediately after removal.

Avertissement

Le filtre d'alimentation contient des condensateurs qui peuvent rester chargés une fois l'appareil débranché de l'alimentation électrique. L'énergie résiduelle est dans les limites des exigences de sécurité approuvées. Par contre, un léger choc électrique peut être ressenti si l'on touche les broches de la prise immédiatement après son débranchement.

Input Overload

Refer to product labeling and safety documentation for maximum input ratings.



CAUTION

Do not overload input connectors. Refer to product Safety and Compliance Specifications or the product data sheet for maximum input ratings.

Mise en Garde

Ne surchargez pas les connecteurs d'entrée. Reportez-vous aux spécifications du produit ou à la fiche technique du produit pour connaître les valeurs d'entrée maximales.

AC Adapter/Charger

The replacement part number: 22160651: PSD90-3 Charger Universal; 90-264VAC; 47-63Hz



CAUTION

- Only use the AC Adapter/Charger supplied with the instrument.
- Do not use the AC Adapter/Charger in a wet or damp location.
- Only connect the AC Adapter/Charger to the correct mains voltage indicated on the ratings label.

Mise en Garde

- Utilisez uniquement l'adaptateur / chargeur CA fourni avec l'instrument.
- N'utilisez pas l'adaptateur / chargeur CA à l'extérieur ou dans un endroit mouillé ou humide.
- Connectez uniquement l'adaptateur / chargeur CA à la tension secteur correcte indiquée sur l'étiquette des caractéristiques nominales.

Battery Safety Information

The battery included with the product is only to be used with the Product Name/Model Number. Do not use the battery included with the Product Name/Model Number with other VIAVI products unless indicated in product documentation.

Battery Replacement



The battery supplied with the device should only be replaced with a VIAVI approved replacement part.

47604: Battery Rechargeable 12V 2.9 AH

Battery Storage, Handling and Disposal



CAUTION

- To avoid risk of fire and burns, do not tamper with the battery.
- Do not open, crush or incinerate the battery.
- Do not use or store the battery in temperatures that exceed the manufacturer's specifications. Follow manufacturer's instructions for battery storage and use.

Mise en Garde

- Pour éviter tout risque d'incendie et de brûlure, ne modifiez pas la batterie.
- Ne pas ouvrir, écraser ou incinérer la batterie.
- N'utilisez pas et ne stockez pas la batterie à des températures dépassant les spécifications du fabricant. Suivez les instructions du fabricant pour le stockage et l'utilisation de la batterie.

Electrostatic Discharge (ESD)



CAUTION

Internal components are ESD sensitive and should only be installed, removed and/or serviced by Qualified Service Personnel.

Mise en Garde

Les composants internes sont sensibles au DES et ne doivent être installés, retirés ou entretenus que par du personnel de maintenance qualifié.

Case/Cover Removal

Do not operate this device with the case or covers removed.



CAUTION

This device does not contain user serviceable parts. Servicing should only be performed by Qualified Service Personnel.

Mise en Garde

Cet appareil ne contient pas de pièces pouvant être entretenues par l'utilisateur. L'entretien doit seulement être effectué par du personnel de service qualifié.

China RoHS Material Disclosure

“中国 RoHS”

《电子信息产品污染控制管理办法》（信息产业部，第 39 号）

附录 (Additional Information required for the Chinese Market only)

本附录按照“中国 RoHS”的要求说明了有关电子信息产品环保使用期限的情况，并列出了产品中含有的有毒、有害物质的种类和所在部件。本附录适用于产品主体和所有配件。

产品系列: PSD90-3
(Product Family)

环保使用期限:



本标识标注于产品主体之上，表明该产品或其配件含有有毒、有害物质（详情见下表）。

其中的数字代表在正常操作条件下至少在产品生产日期之后数年内该产品或其配件内含有的有毒、有害物质不会变异或泄漏。该期限不适用于诸如电池等易耗品。

有关正常操作条件，请参见产品用户手册。

产品生产日期请参见产品的原始校准证书。

有毒、有害物质的类型和所在部件

元器件 (Component)	有毒、有害物质和元素					
	铅(Pb)	汞 (Hg)	镉(Cd)	六价铬 (CR ⁶⁺)	多溴联苯 (PBB)	多溴二苯醚 (PBDE)
产品主体 (Main Product)						
印刷电路板组件 (PCB Assemblies)	X	O	O	O	O	O
内部配线 (Internal wiring)	X	O	O	O	O	O
显示器 (Display)	O	O	O	O	O	O
电池 (Batteries)	X	O	O	O	O	O
电源 (Power Supply)	O	O	O	O	O	O
电工零件 (Electro-mechanical parts)	X	O	O	O	O	O
金属外壳零件和紧扣件 (Metal case parts and fixings)	X	O	O	O	O	O
塑料外壳零件 (Plastic case parts)	O	O	O	O	O	O
标签和胶带 (Labels and tapes)	O	O	O	O	O	O
配件 (Accessories)						
外接电缆和适配器 (External cables and adapters)	X	O	O	O	O	O
手册和其它印刷材料 (Handbooks and other printed material)	O	O	O	O	O	O
包装箱和缚带 (Carrying case and strap)	O	O	O	O	O	O
其它配件 (Other accessories)	O	O	O	O	O	O

本表是按照 SJ / T 11364 的规定编制的：
O: 表示该有害物质在该部件所有均质材料中的含量均在 GB/T 26572 规定的限量要求以下。
X: 表示该有害物质至少在该部件的某一均质材料中的含量超出 GB/T 26572 规定的限量要求。

This page intentionally left blank.



Table of Contents

Safety and Compliance Information	vii
Table of Contents	xv
List of Figures	xix
List of Tables	xxi
Chapter 1	Introduction 1-1
	1.1 Introduction 1-2
	1.2 Equipment and accessories 1-2
	1.2.1 Versions, options, and accessories 1-2
	1.2.2 PSD30-2AF adapter cable. 1-5
	1.3 Test Set description 1-5
	1.4 Unpacking and inspecting equipment. 1-13
	1.5 Specifications 1-13
Chapter 2	Operation 2-19
	2.1 General Information 2-21
	2.2 Power On 2-21
	2.3 Self-test. 2-21
	2.3.1 ADC Calibration 2-22
	2.3.2 Ohmmeter functional test. 2-23
	2.3.3 AC CAP functional test 2-23
	2.3.4 Cap simulator functional test 2-23
	2.3.5 Variable frequency functional test 2-23
	2.4 Resistance measurement. 2-23
	2.4.1 Low voltage resistance measurement mode 2-23
	2.4.2 Resistance measurement mode 2-24

	2.4.3 Resistance manual range selection	2-25
	2.5 Capacitance measurement	2-26
	2.5.1 AC capacitance measurement	2-26
	2.5.2 AC Capacitance manual range selection	2-26
	2.5.3 DC capacitance measurement	2-26
	2.5.4 DC capacitance manual range selection	2-27
	2.5.5 OEM DC measurement	2-27
	2.5.6 OEM DC capacitance manual range selection	2-28
	2.6 Capacitance simulation	2-28
	2.7 DTF measurement	2-29
	2.7.1 DTF measurement mode	2-29
	2.8 DVM MEASUREMENT	2-30
	2.8.1 DVM MEASUREMENT MODE	2-30
	2.9 Contaminated Probe	2-30
	2.9.1 AC/DC Automatic contaminated probe detection	2-30
	2.9.2 Setting AC/DC Contaminated Probe threshold	2-31
	2.9.3 Probe Check measurement	2-31
	2.9.4 Probe Check manual range selection	2-31
	2.9.5 Setting Probe Check Contaminated Probe threshold	2-32
	2.10 Error codes	2-33
Chapter 3	Theory of Operations	3-35
	3.1 Design architecture	3-36
	3.1.1 Main board	3-36
	3.1.2 Display board	3-36
	3.1.3 IO board	3-36
	3.2 Contaminated probe detector	3-36
Chapter 4	Maintenance	4-39
Chapter A	Appendix A: RCI commands	A-41
	A.1 Introduction	A-42
	A.2 RS-232 Setup	A-42
	A.3 Common commands	A-43
	A.3.1 IDN	A-43
	A.3.2 RST	A-43
	A.3.3 OPC	A-43
	A.3.4 TST	A-44
	A.4 Front Panel Switch Control	A-44
	A.4.1 Power/Type Select Switch	A-44
	A.4.2 Function Select Switch Control	A-45
	A.4.3 Meg Mode/Simulator Mode Switch Control	A-46
	A.4.4 Megger Select Switch (ACMODE)	A-47

A.4.5	Megger Select Switch (DCMODE)	A-48
A.4.6	Simulator Coarse Switch	A-49
A.4.7	Simulator Fine Switch	A-49
A.5	Capacitance Simulation	A-49
A.5.1	Capacitance Simulation Value	A-50
A.5.2	Simulation Mode	A-51
A.5.3	Calibration	A-51
A.6	AC CAP Measure	A-52
A.6.1	Measurement range.	A-52
A.6.2	Read measurement	A-53
A.7	DC CAP Measure	A-54
A.7.1	Measurement Range	A-54
A.7.2	Read Measurement	A-55
A.8	OEMDC Measure	A-55
A.8.1	Measurement Range	A-55
A.8.2	Manufacturer Setting	A-56
A.8.3	Read Measurement	A-56
A.9	Probe Check	A-57
A.9.1	Measurement range.	A-57
A.9.2	Read Measurements	A-58
A.10	Megger Measurement.	A-58
A.10.1	Measurement Range	A-59
A.10.2	Read Measurement	A-60
A.11	Distance to Fault.	A-60
A.11.1	Read Measurement	A-60
A.12	Digital Volt Meter.	A-60
A.12.1	Read Measurement	A-60

This page intentionally left blank.



List of Figures

Figure 1-1 . . . PSD30-2AF adapter cable.	1-5
Figure 1-2 . . . PSD90-3 Test Set and accessories.	1-6
Figure 1-3 . . . Front panel	1-7
Figure A-1 . . . Interface cable.	A-42

This page intentionally left blank.



List of Tables

Table 1-1	PSD90-3 Versions, options, and accessories	1-2
Table 1-2	PSD90-3 standard and optional accessories	1-3
Table 1-3	PSD90-3 front panel	1-8
Table 1-4	Capacitance Measurement	1-13
Table 1-5	Capacitance Simulation	1-14
Table 1-6	Resistance Measurement	1-15
Table 1-7	Distance to Fault (DTF) measurement	1-15
Table 1-8	Voltage measurement	1-15
Table 1-9	Environmental	1-15
Table 1-10	Power Requirements	1-16
Table 1-11	Physical characteristics	1-16
Table 1-12	Test Set certifications	1-16
Table 1-13	Features	1-17
Table 2-1	Self-Test Fail codes	2-22
Table 2-2	Display indication and measurement range	2-32
Table 2-3	Error Codes	2-33

This page intentionally left blank.

Introduction

This chapter provides a general description of the PSD90-3. Topics discussed in this chapter include the following:

- Equipment and accessories 1-2
 - Versions, options, and accessories. 1-2
 - PSD30-2AF adapter cable 1-5
- Test Set description 1-5
- Unpacking and inspecting equipment 1-13
- Specifications 1-13

1.1 Introduction

This manual provides operation information for the PSD90-3 Universal AC/DC Fuel Quantity Test Set.

The PSD90-3 Universal AC/DC Fuel Quantity Test Set is an instrument that permits complete functional checkout and calibration of an AC or DC Fuel Quantity System, on or off the aircraft. The test set can accurately measure the capacitance of Tank Units, Compensators, or entire systems. The test set can also simulate capacitance values for the operation of Indicators, as well as measure the insulation resistance of Tank Units and cabling.

Operation of the test set is automatic, with no manual nulling required. To evaluate a particular system, connect the PSD90-3 to the applicable unit. Panel controls are set to determine what is displayed on the digital display.

A rechargeable Lead Acid sealed battery powers the test set. The battery may be replaced without the need of test set recalibration. Battery charge is displayed on the digital readout.

The test set is shipped with a chassis ground cable and power cord. In order to properly test a system, specific aircraft interface cables are required but not furnished with the test set.

The PSD90-3 versions are:

- PSD90-3 AC/DC Fuel Quantity Test Set (22160648)
- PSD90-3AC Fuel Quantity Test Set (22160649)
- PSD90-3DC Fuel Quantity Test Set (22165792)
- PSD90-3-F16 Fuel Quantity Test Set (22165794)

1.2 Equipment and accessories

The following sections describe the equipment and accessories.

1.2.1 Versions, options, and accessories

Table 1-1 describes the versions, options, and accessories.

Table 1-1 PSD90-3 Versions, options, and accessories

Order Number	Description
22160648	PSD90-3 AC/DC Fuel Quantity Test Set
22160649	PSD90-3AC Fuel Quantity Test Set
22165792	PSD90-3DC Fuel Quantity Test Set
22165794	PSD90-3-F16 Fuel Quantity Test Set

Table 1-1 PSD90-3 Versions, options, and accessories

Order Number	Description
Aircraft specific interface cables are required and must be purchased separately. Contact VIAVI for your application.	
Standard Accessories	
22160651	PSD90-3 Charger Universal; 90-264VAC; 47-63Hz
22166183	Operations Manual PSD90-3
57947	F-16 Interface Adapter Cable (22165794 only)
38647	Connector BNCF Rev. Polarity
38648	Connector BNCFM Rev. Polarity (qty 2)
57929	Ground Cable
Optional Accessories	
22160650	PTS-3 Calibration Standard
22165793	PSD30-2AF Interface Adapter
22166181	Maintenance Manual
Software Options¹	
22166784	AC Software Option
22166785	DC Software Option
22167891	OEM DC Software Option

1. Software options must be installed at a VIAVI factory or by an authorized VIAVI service center.

Table 1-2 describes the accessories for the PSD90-3.

Table 1-2 PSD90-3 standard and optional accessories



ACC Part Number (Legacy P/N)	Description	Application	
Standard accessories			
22160651	Universal Charger 90-264VAC; 47-63Hz	Used for charging the internal batteries or operating the PSD90-3 for depot or bench level applications. Not recommended during on-aircraft use.	
38647 (PSD40-524A) (30-0284-01)	Adapter BNC-F Reverse Polarity	Polarized BNC Adapter, Female to Female. Adapts PSDAF-XXX cables to the PSD40, and PSD60-2R where the connector polarity is opposite.	

Table 1-2 PSD90-3 standard and optional accessories





ACC Part Number (Legacy P/N)	Description	Application	
38648 (PSD40-524B) (30-0284-01)	Adapter BNC-M Reverse Polarity (Qty 2)	Polarized BNC Adapter, Male to Male. Adapts existing PSD60-XXX and PSD40-XXX cables to the PSD90-3 where the connector polarity is opposite	
57929	Ground Cable	Used to ground the PSD90-3 to the aircraft ground	
57947	F-16 Interface Adapter Cable	Used only with the PSD90-3-F16 configuration, used to connect the PSD90-3 to the Goodrich 472844 or VIAVI PSD90S-F16 interface units.	
22166183	Operations Manual (CD)	The operations manual provides test set operation detail for all switches, controls and indicators.	
Optional accessories			
22160650	PTS-3 Calibration Standard	Used to calibrate the PSD90-3 for Resistance, AC/DC and OEM DC Capacitance.	
22165793	PSD30-2AF Interface Adapter	Used to adapt current PSD30-2AF FQIS interface cables with the circular connector to the PSD90-3.	

Table 1-2 PSD90-3 standard and optional accessories

ACC Part Number (Legacy P/N)	Description	Application
22166181	Maintenance Manual (CD)	The maintenance manual provides detail on how to maintain, service, calibrate and verify the PSD90-3 to the module level.
Various	Aircraft FQIS Interface Cables and Units Sold Separately	Allows for interfacing to a specific aircraft's FQIS for testing and troubleshooting. Unique test requirements are built into the interface test set.

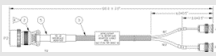

1.2.2 PSD30-2AF adapter cable

The PSD30-2AF adapter cable may be required to adapt existing PSD30-2 fuel quantity interface cables with Banana Jack type leads to the PSD90-3. Figure shows the details PSD30-2AF adapter cable. This information is provided to locally manufacture this cable if required.

Figure 1-1 PSD30-2AF adapter cable

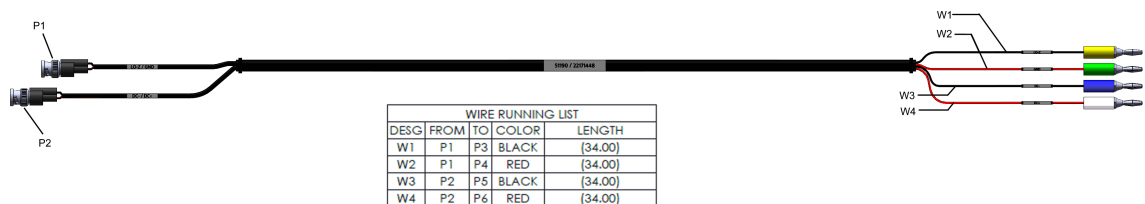

This cable is built from Pomona Electronics EM970-36# flying lead of equivalent, which includes P1/P2. The 4 Banana Plug Binding Posts are common, such as:

- 108-0301-011 White
- 108-0304-001 Green
- 108-0307-001 Yellow
- 108-0310-001 Blue

1.3 Test Set description

Figure 1-2 shows the test set and accessories.

Figure 1-2 PSD90-3 Test Set and accessories



Figure 1-3 shows the front panel of the test set.

Figure 1-3 Front panel

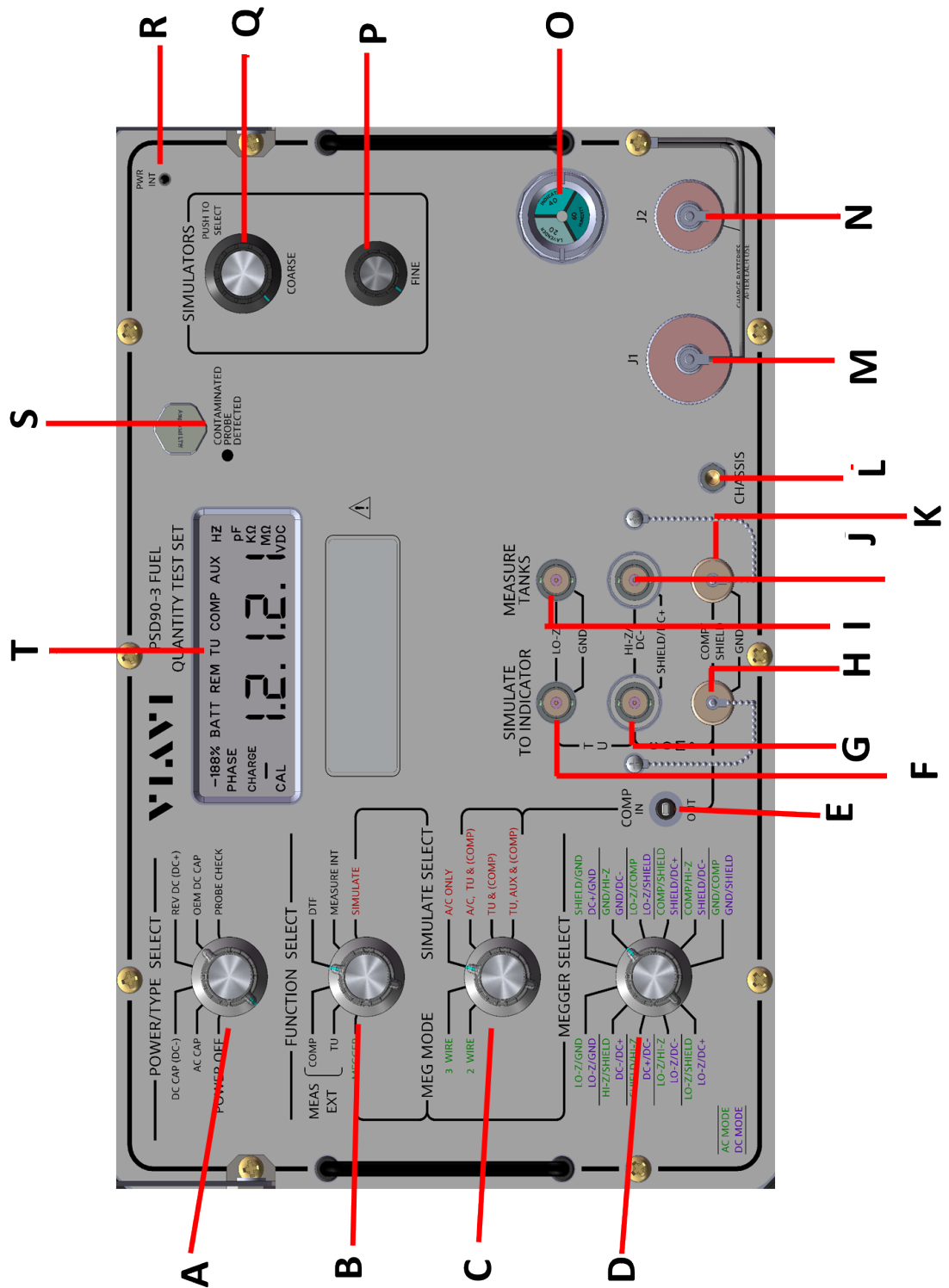

Table 1-3 describes the function of each item.

Table 1-3 PSD90-3 front panel

Item	Name	Description
A	POWER/TYPE SELECT	<p>Turns the unit power on/off and selects between AC/DC capacitance measurement simulation and capacitance, and the contaminated probe check function.</p> <ul style="list-style-type: none">– POWER OFF– AC CAP– DC CAP (DC-)– REV DC (DC+)– OEM DC CAP– PROBE CHECK
	WARNING	<p>The Power switch on the Front Panel is not the mains disconnect. Mains disconnect is accomplished by disconnecting the detachable power supply cord at the appliance coupler or at the mains plug. Ensure the power cord is easily accessible and removable in the event of an emergency, which requires immediate disconnection.</p>
	NOTE	<p>The battery charger is always powered whenever the unit is connected to external power.</p> <p>When the battery is actively being charged, the CHARGE indicator is illuminated on the PSD90-3 display. Once the battery is fully charged, the CHARGE indicator is turned off.</p>

Table 1-3 PSD90-3 front panel

Item	Name	Description
B	FUNCTION SELECT	<p>Selects the function to be performed:</p> <p>COMP – Sets the unit to measure external COMP capacitance.</p> <p>TU – Sets the unit to measure external TU capacitance.</p> <p>DTF – Sets the unit to measure Distance To Fault capacitance.</p> <p>MEGGER – Sets the unit to measure insulation resistance as determined by the position of the MEGGER SELECT switch.</p> <p>SIMULATE – Sets the unit to simulate capacitance as determined by the position of the SIMULATE SELECT switch.</p> <p>MEASURE INT – Sets the unit to measure internal capacitance from the simulators.</p>

Table 1-3 PSD90-3 front panel

Item	Name	Description
C	MEG MODE/SIMULATE SELECT	<p>Selects the simulation/ohmmeter measuring mode to be performed:</p> <ul style="list-style-type: none"> – 2-Wire – Sets the resistance measurement to 2-Wire mode. – 3-Wire – Sets the resistance measurement to 3-Wire mode. – A/C Only – Disconnects the internal simulator to allow simulation of aircraft only. – A/C, TU, & (COMP) – Connects aircraft and internal TU and COMP simulators to simulate indicator jacks. COMP simulation is only added when the COMP IN/OUT switch is set to the IN position. – TU & (COMP) – Connects the internal TU and COMP simulators to the SIMULATE TO INDICATOR jacks. COMP simulation is only added when the COMP IN/OUT switch is set to the IN position. – TU, AUX & (COMP) – Connects the TU, AUX and COMP simulators to the SIMULATE TO INDICATOR jacks. COMP simulation is only added when the COMP IN/OUT switch is set to the IN position.
D	MEGGER SELECT	Determines the two points between which the resistance measurement is to be made. It is only recognized when FUNCTION SELECT is set to MEGGER and the unit is in Resistance measurement mode.
E	COMP IN/OUT	Inserts or removes the COMP capacitance.
F	INDICATOR LO-Z	Allows connection from test set SIMULATOR LO-Z to aircraft Fuel Quantity Indicators.
G	INDICATOR HI-Z	Allows connection from test set SIMULATOR HI-Z to aircraft Fuel Quantity Indicators.

Table 1-3 PSD90-3 front panel

Item	Name	Description
H	INDICATOR COMP	Allows connection from the test set COMP SIMULATOR to aircraft Fuel Quantity Indicators.
I	TANK UNITS LO-Z	Allows connection from test set excitation circuits to aircraft tanks for measurement, and connects aircraft tanks to SIMULATE TO INDICATOR jacks in A/C mode.
J	TANK UNITS HI-Z	Allows connection from test set measurement circuits to aircraft tanks for measurement and connects aircraft tanks to SIMULATE TO INDICATOR jacks in A/C mode.
K	TANK UNITS COMP	Allows connection from test set excitation circuits to aircraft tanks for measurement and connects aircraft tanks to SIMULATE TO INDICATOR jacks in A/C mode.
L	CHASSIS	Banana Jack connector that provides external contact point for the system GND. This is used to connect test set GND to aircraft GND.
M	J1 Circular Connector	DVM Mode Selection DVM Connection Battery Connection RS232 Connection Calibration Selection
N	J2 Battery Charging Connector	Allows for AC Mains connection to recharge battery.
O	Desiccant Indicator	Externally visible indication of the present and past moisture content exposure the unit has undergone.

Table 1-3 PSD90-3 front panel

Item	Name	Description
P	SIMULATORS FINE	Multi-functional knob for fine control of user input values. Used: <ul style="list-style-type: none">– For fine control during calibration and during setup of capacitance simulation values.– To set the limits where the Contaminated Fuel Probe LED illuminates.– To change the OEM Type while in OEM DC. Press and hold, then rotate to the desired OEM type.
Q	SIMULATORS COARSE	Multi-functional knob used: <ul style="list-style-type: none">– During calibration for controlling input values and during capacitance simulation for resolution at 1pF below 400pF, and 10 pF above 400 pF.– As a push-button switch that is used during calibration to proceed to the next step– During simulation to change between: "TU", "COMP", and "AUX".– During resistance or capacitance measurements to manually set the range.– When initially entering OEM DC mode, rotate to the desired OEM Type, then press down on the knob to select.
R	Power Interrupt/Kill-Switch	Push-button switch that is depressed when the lid is closed, turning off power to the unit.

Table 1-3 PSD90-3 front panel

Item	Name	Description
S	Contaminated Probe LED	Red LED that is illuminated when a contaminated probe is detected at a level that exceeds the user set trip point. Only active in the automatic and manual contaminated fuel probe functions.
	NOTE	This measurement is only available in AC and DC capacitance modes.
T	Custom LED Display	Displays: <ul style="list-style-type: none"> – Capacitance under test, either internal or external – Insulation and continuity resistance of system wiring or unit under test – Voltage of the unit under test – Relative charge of the PSD90-3 batteries – Mode of operation – Degree of error for contaminated fuel probes.

1.4 Unpacking and inspecting equipment

Exercise care when unpacking the unit. Make a visual inspection of the unit for evidence of damage incurred during shipment. If a claim for damage is to be made, save the shipping container to substantiate the claim. When the equipment has been unpacked, return all the packing material to the container for future use in storing or shipping of the equipment.

1.5 Specifications

The following tables describe the specifications.

Table 1-4 Capacitance Measurement

Capacitance Measurement Modes
AC
DC
OEM DC
Capacitance Measurement

Table 1-4 Capacitance Measurement

Range	0.000 pF – 39999 pF
Accuracy	Greater of $\pm 0.1\%$ of reading or ± 0.05 pF
Range (pF)	Resolution
0.000 - 39.999 (Manual Range only)	0.001
0.00 - 399.99	0.01
400.0 - 3999.9	0.1
4000 - 3999939999 (AC and True DC only)	1

Table 1-5 Capacitance Simulation

Accuracy	Greater of $\pm 0.1\%$ of reading or ± 0.05 pF From 300 Hz to 10,000 Hz
Simulation Range (pF)	Resolution (pF)
TU	
0.00 – 399.99	0.01
400 – 3999.9 AC or DC	0.1
4000 – 14500	1
COMP	
0.00 - 399.99	0.01
400.0 - 1250.0	0.1
AUX	
0.00 - 399.99	0.01
400.0 - 3999.9 AC or DC	0.1
400.0 - 1999.9 OEM DC	0.1
4000 - 14500	1

Table 1-6 Resistance Measurement

Accuracy	Greater of $\pm 2\%$ of reading or 0.05Ω $\pm 5\%$ of reading in manual ranges and Extended Meg range
Measurement Range (Ω)	Resolution (Ω)
0.000 – 39.999 (AC and DC only)	0.001
0.000 – 399.99	0.01
400 – 3999.9	0.1
4.000 K - 39.999 K	0.001 K
40.00 K - 399.99 K	0.01 K
400.0 K - 3999.9 K	0.1 K
4.000 M - 39.999 M	0.001 M
40.00 M - 399.99 M	0.01 M
400.0 M - 3999.9 M	0.1 M
4000 M - 19999 M	1 M
0.0000 nS - 3.9999 nS (Manual Range only)	0.0001 nS

Table 1-7 Distance to Fault (DTF) measurement

Range	0 pF – 39999 pF
Accuracy	$\pm 0.1\%$ of reading ± 1 pF
Resolution	1 pF – 1 range

Table 1-8 Voltage measurement

Range	-33.999 V – +33.999 VDC
Accuracy	Greater of $\pm 0.2\%$ of reading or ± 2 mV
Resolution	0.001 V - 1 range
Impedance	1.0 M Ω

Table 1-9 Environmental

Operating Temperature	-40° C to +55° C
Storage Temperature	-51° C to +71° C

Table 1-10 Power Requirements

Battery	1 Rechargeable 12 V Lead Acid Gel Cell NSN: 6140-01-213-0199
Operation	12 hours minimum from -10° C to +50° C (Lower operation time beyond these temperatures)
Charge Time	8 hours max from fully discharged battery
Charge Input	100 – 240 VAC from 45 – 60 Hz 100 – 130 VAC from 380 – 440 Hz
Charge Temp	-20° C to +50° C (Charger will operate unit beyond these temperatures but will not charge battery)

Table 1-11 Physical characteristics

Height	10.6" (26.9 cm)
Width	14" (35.6 cm)
Depth	6.5" (16.5 cm)
Weight	13 lbs (5.9 kg)

Table 1-12 Test Set certifications

Altitude (operating)	MIL-PRF-28800F, Class 2
Altitude (not operating)	MIL-PRF-28800F, Class 2
Bench Handling	MIL-PRF-28800F, Class 2
Blowing Dust	MIL-STD-810F, Method 510.4, Procedure 1
Splash proof	MIL-PRF-28800F, Class 2
Explosive Atmosphere	MIL-STD-810F, Method 511.4, Procedure 1
Relative Humidity	MIL-PRF-28800F, Class 2
Solar Radiation	MIL-PRF-28800F, Class 2
Salt Atmosphere	MIL-PRF-28800F, Class 2
Shock (Functional)	MIL-PRF-28800F, Class 2
Vibration Limits	MIL-PRF-28800F, Class 2
Transit-Drop	MIL-PRF-28800F, Class 2
Safety Compliance	UL-61010-1, EN-61010-1, CSA 22.2 No 61010-1
EMC	EN-61326-1

Table 1-13 Features

True closed-box calibration
Auto and manual ranging
Fully remote controllable via RS-232
Backlit display
CE certified
Meets safety requirements of Boeing 10-61959 specification
Self-Test on Power up
DTF function displayed in capacitance

This page intentionally left blank.

Operation

This chapter provides operational instructions for the PSD90-3. Topics discussed in this chapter include the following:

- Power On 2-21
- Self-test 2-21
 - ADC Calibration 2-23
 - Ohmmeter functional test 2-23
 - AC CAP functional test 2-23
 - Cap simulator functional test. 2-23
 - Variable frequency functional test. 2-23
- Resistance measurement 2-23
 - Low voltage resistance measurement mode. 2-23
 - Resistance measurement mode 2-24
 - Resistance manual range selection 2-25
- Capacitance measurement 2-26
 - AC capacitance measurement 2-26
 - AC Capacitance manual range selection 2-26
 - DC capacitance measurement 2-26
 - DC capacitance manual range selection. 2-27
 - OEM DC measurement. 2-27
 - OEM DC capacitance manual range selection 2-28
- Automatic capacitance simulation 2-28
- DTF measurement 2-29
 - DTF measurement mode 2-29
- DVM MEASUREMENT 2-30
 - DVM MEASUREMENT MODE 2-30
- Contaminated Probe 2-30
 - AC/DC Automatic contaminated probe detection 2-30
 - Setting AC/DC Contaminated Probe threshold. 2-31

- Probe Check measurement 2-31
- Probe Check manual range selection 2-31
- Setting Probe Check Contaminated Probe threshold 2-32
- Error codes 2-33

2.1 General Information

The PSD90-3 is a general purpose test set and must be used in conjunction with an aircraft specific interface cable in order to gain access to the aircraft fuel quantity system. Contact VIAVI for interface cabling information on specific systems.

The following precautions should be observed at all times:



WARNING

Connect the PSD90-3 chassis jack to airframe ground before making other connections, and keep connected during all test set operations (measurement and simulation) unless otherwise specified in aircraft-specific procedures. Disconnect chassis jack only after all other connections have been discontinued.



WARNING

When using in hazardous environment locations, the PSD90-3 test set should only be operated from the internal battery. Do not operate on external power in a hazardous environment.



WARNING

Only connect the PSD90-3 to external power in dry non-hazardous locations.



WARNING

Power cord connection to Front Panel connector must be clean and dry before attaching. Replace protective cap on the Front Panel connector whenever power cord is not connected.

The PSD90-3 battery should be recharged prior to first use and after every subsequent use. For maximum battery life, the battery should be charged at least once every three months.

2.2 Power On

- Rotate the POWER/TYPE SELECT switch from POWER OFF to any of the other five options.
- Upon powering on, the unit automatically runs a self-test.

2.3 Self-test

The following tests are performed on power-up. If a test fails, the appropriate error code is set:

1. Analog to Digital Converter (ADC) Calibration
2. Ohmmeter function test
3. AC CAP functional test
4. CAP simulator functional test
5. Variable frequency functional test.

While the self-test is performed, all segments are briefly shown to allow the user to verify all of the segments are functioning. Following this, the loaded software version is shown briefly.

If no failure is found, the test set will show PASS. Otherwise, the test set will show FAIL, followed by a code. [Table 2-1](#) lists the possible codes.

Table 2-1 Self-Test Fail codes

Code	Description
SPI1	SPI1 Bus comm failure
SPI2	SPI2 Bus comm failure
CRC	Missing or corrupted calibration data
ADC1	ADC1 failed functional test
ADC2	ADC2 failed functional test
ADC3	ADC3 failed functional test
REF	Internal Reference capacitor failed
CAP	AC CAP failed functional test
SLOP	Microbe Slope detector failed functional test
SCAP	Simulator failed functional test
RES	Ohmmeter failed functional test
OPT	Missing or corrupted options ¹
UREF	Variable frequency failed capacitive functional test
URES	Variable frequency failed resistive functional test
PLL	Phase-Lock-Loop failure

1. This error code is also displayed if the operator selects a function for an option that is not installed.

If the test set failed self-test, it will continually cycle through the failure codes. Operation of the test set can be continued by pressing twice on the SIMULATOR COARSE switch, or by sending a remote command through the RS-232 interface.

2.3.1 ADC Calibration

This test performs the calibrations of each ADC, which also doubles as the ADC functional test.

2.3.2 Ohmmeter functional test

This test verifies that the ohmmeter measurement circuitry is working correctly by measuring a known resistance.

2.3.3 AC CAP functional test

This test verifies that the capacitance measurement circuitry is working correctly by measuring a known capacitance. This test also verifies that the microbe slope detector is functioning properly.

2.3.4 Cap simulator functional test

This test verifies that the capacitance simulator is functioning correctly.

2.3.5 Variable frequency functional test

This test verifies that the variable frequency capacitance circuitry is working correctly. This circuitry is used in PROBE CHECK operation.

2.4 Resistance measurement

2.4.1 Low voltage resistance measurement mode

In some instances, aircraft wiring connections can be corroded (fritted.) The corrosion can interrupt an electrical connection and cause a failure. Using test equipment with a higher voltage can temporarily break through this corrosion and make the electrical connection. This new electrical connection is temporary and may fail in the future. The Low Voltage Resistance Measurement Mode does not break through the corrosion. To use the Low Voltage Resistance Measurement Mode, the following procedure needs to be followed in order to not destroy the corrosion.



NOTE

All other resistance modes have a higher voltage and will temporarily burn through the corrosion. The test set must be placed in the Low Voltage mode before connecting the PSD90-3 to the aircraft.

1. Connect CHASSIS jack to Airframe.
2. Do not connect the PSD90-3 to the Aircraft Interface.
3. Turn POWER/TYPE SELECT switch to REV DC (DC+), DC CAP (DC-), AC CAP, or OEM DC, depending on the system under test.
4. Turn the FUNCTION SELECT switch to MEGGER.
5. Place the unit in Low Voltage Manual Range as described in [“Resistance manual range selection” on page 25](#).
6. Connect TANK UNITS LO Z, HI Z and COMP connectors to the aircraft interface with the appropriate interface cables.
7. Select the type of measurement to be performed 2-wire or 3-wire using the MEG MODE SIMULATE SELECT switch.
8. Install a jumper at the far end of the cable to be measured. The jumper is to be installed between the cable being measured and any other cable that can supply a return path to the PSD90-3.
9. Using the MEGGER SELECT switch, select the two points at which the jumper is installed. Example: If the LO-Z cable is being measured and ground is the return path, then select the LO-Z/GND position.
10. The resistance between the points selected will be displayed in ohms on the test set display.

2.4.2 Resistance measurement mode

1. Connect CHASSIS jack to Airframe.
2. Turn POWER/TYPE SELECT switch to REV DC (DC+), DC CAP (DC-) or AC CAP, depending on the system under test. Allow one minute for test set to stabilize.
3. Connect TANK UNITS LO Z, HI Z and COMP connectors to the aircraft interface with the appropriate interface cables.
4. Turn the FUNCTION SELECT switch to MEGGER.
5. Select the type of measurement to be performed 2-wire or 3-wire using the SIMULATE SELECT switch.
6. Select desired points to be measured using the MEGGER SELECT switch.
7. The resistance between the points selected will be displayed in ohms on the test set display.

2.4.3 Resistance manual range selection

1. Set up for resistance measurement using the RESISTANCE MEASUREMENT MODE procedure.
2. Push the SIMULATOR COARSE switch to select manual range selection. Rotate the SIMULATOR COARSE switch to select the range. The following table identifies the display indication and the measurement range.

Resistance Range Description	Display Indication	Resistance Measurement Range
Auto	Auto Ω /M Ω	0.00 Ω – 19990 M Ω
Low Voltage	39.999 Ω	0.000 Ω – 39.000 Ω
Low Ohm	399.99 Ω	0.00 Ω – 399.99 Ω
Medium Ohm	3999.9 Ω	0.0 Ω – 3999.9 Ω
High Ohm	39.999 K Ω	0.000 K Ω – 39.999 K Ω
Extended Ohm	399.99 K Ω	0.00 K Ω – 399.99 K Ω
Low Mohm	3999.9 K Ω	400.0 K Ω – 3999.9 K Ω
Medium Mohm	39.999 M Ω	0.400 M Ω – 39.999 M Ω
High Mohm	399.99 M Ω	0.40 M Ω – 399.99 M Ω
Extended Mohm	3999.9 M Ω	0.4 M Ω – 3999.9 M Ω
High Extended Mohm	19999 M Ω	4 M Ω – 19990 M Ω
Mhos	3.9999 nS	.0000 nS – 3.9999 nS



NOTE

Conductivity is displayed on the PSD90-3 in Siemens. 1 Siemen = 1 Mho = 1/Ohm.

3. To select the range, rotate through the display indication screens until the screen that is to be selected is displayed. After 2 seconds that range will be selected. If AUTO is selected, step 2 needs to be redone to change back to the manual range.

2.5 Capacitance measurement

2.5.1 AC capacitance measurement

1. Connect CHASSIS jack to Airframe.
2. Turn POWER/TYPE SELECT switch to AC CAP.
3. Connect TANK UNITS LO Z and HI Z connectors to the aircraft interface with the appropriate interface cables.
4. Turn FUNCTION SELECT switch to MEASURE EXT/COMP or MEASURE EXT/TU.
5. The capacitance of the system's TU is measured and displayed in pF on the test set's display.

2.5.2 AC Capacitance manual range selection

1. Set up for AC capacitance measurement using the AC CAPACITANCE MEASUREMENT procedure.
2. Push the SIMULATOR COURSE switch to select the manual range selection. Rotate the SIMULATOR COARSE switch to select the range. The following table identifies the display indication and the measurement range.

Capacitance Range Description	Display Indication	Capacitance Measurement Range
Auto	Auto pF	0.00 pF – 39.99 KpF (4 Ranges)
Extra Low	39.999 pF	0.000 pF – 39.999 pF
Low	399.99 pF	0.00 pF – 399.99 pF
Medium	3999.9 pF	0.0 pF – 3999.9 pF
High	39999 pF	0 pF – 39999 pF

3. To select the range, rotate through the display indication screens until the screen that is to be selected is displayed. After 2 seconds that range will be selected. If AUTO is selected, step 2 needs to be redone to change back to the manual range.

2.5.3 DC capacitance measurement

1. Connect CHASSIS jack to Airframe.
2. Turn POWER/TYPE SELECT switch to DC CAP (DC-), or REV DC (DC+), depending on the system under test. Allow one minute for test set to stabilize.

3. Connect TANK UNITS LO Z and HI Z connectors to the aircraft interface with the appropriate interface cables.
4. Turn FUNCTION SELECT switch to MEASURE EXT or MEASURE TU.
5. The capacitance of the system's TU is measured and displayed in pF on the test set's display.

2.5.4 DC capacitance manual range selection

1. Set up for DC capacitance measurement using the DC CAPACITANCE MEASUREMENT procedure.
2. Push the SIMULATOR COARSE switch to select manual range selection. Rotate the SIMULATOR COARSE switch to select the range. The following table identifies the display indication and the measurement range.

Capacitance Range Description	Display Indication	Capacitance Measurement Range
Auto	Auto pF	0.00 pF – 39.99 KpF(4 Ranges)
Extra Low	39.999 pF	0.000 pF – 39.999 pF
Low	399.99 pF	0.00 pF – 399.99 pF
Medium	3999.9 pF	0.0 pF – 3999.9 pF
High	39999 pF	0 pF – 39999 pF

3. To select the range, rotate through the display indication screens until the screen that is to be selected is displayed. After 2 seconds that range will be selected. If AUTO is selected, step 2 needs to be redone to change back to the manual range.

2.5.5 OEM DC measurement

1. Connect CHASSIS jack to Airframe.
2. Turn POWER/TYPE SELECT switch to OEM DC CAP.
3. Rotate the COURSE adjustment switch and press to select the OEM DC type. The options are:
 - TYPE A = Goodrich / Simmonds
 - TYPE B = Smiths USA
 - TYPE C = Ragen Data Systems
 - TYPE D = Liquid Measurement Systems
 - TYPE E = Gull Airborne
 - TYPE F = Smiths England

4. Connect TANK UNITS LO Z and HI Z connectors to the aircraft interface with the appropriate interface cables.
5. Turn FUNCTION SELECT switch to MEASURE EXT/TU.
The capacitance of the system's TU is measured and displayed in pF on the test set's display.

2.5.6 OEM DC capacitance manual range selection

1. Set up for DC capacitance measurement using the DC CAPACITANCE MEASUREMENT procedure.
2. Push the SIMULATOR COARSE switch to select manual range selection. Rotate the SIMULATOR COARSE switch to select the range. The following table identifies the display indication and the measurement range.

Capacitance Range Description	Display Indication	Capacitance Measurement Range
Auto	Auto pF	0.00 pF – 1999.9 pF
Medium	399.99 pF	0.0 pF – 399.99 pF
High	1999.9 pF	0 pF – 1999.9 pF

3. To select the range, rotate through the display indication screens until the screen that is to be selected is displayed. After 2 seconds that range will be selected. If AUTO is selected, step 2 needs to be redone to change back to the manual range.

2.6 Automatic capacitance simulation

1. Connect CHASSIS jack to Airframe.
2. Turn POWER/TYPE SELECT switch to AC CAP, DC CAP, OEM DC, or REV DC. Allow one minute for test set to stabilize.
3. Turn FUNCTION SELECT switch to MEASURE INT.
4. Connect INDICATOR LO Z and HI Z connectors to the aircraft interface with the appropriate interface cables.
5. Push the SIMULATOR COARSE switch to select TU, AUX, or TU AND AUX. Adjust approximately to desired capacitance value.
6. Adjust the FINE knob to desired capacitance value.
7. Turn FUNCTION SELECT switch to SIMULATE. This connects the simulators to the SIMULATE TO INDICATOR connectors.

8. Turn the MEG MODE SIMULATE SELECT switch to either A/C, TU & (COMP); TU & (COMP); or TU, AUX & (COMP) to simulate the appropriate conditions.

NOTE

The TU AND AUX setting shows the total of the two combined simulation values.

9. The SIMULATOR COURSE switch will still adjust the TU, COMP or AUX simulators while in simulate mode. The corresponding FINE knob still adjusts the simulators. The display will indicate DVM voltage measurement.

NOTE

Any adjustments made in TU, AUX & (COMP) will only affect the AUX simulation value and not the TU value.

NOTE

Connecting test harnesses and interface boxes should not add capacitance to the system. However, if the cable is suspect, connect only the cable to MEASURE LO-Z, MEASURE HI-Z, and MEASURE COMP and read its capacitance per measurement procedure. If cable capacitance is less than 1 pF above displayed reading with no cables connected to test set, subtract its capacitance from the amount being simulated. If over 1 pF, repair cable; shields are probably improperly terminated.

NOTE

The AIRCRAFT ONLY position disconnects all internal simulators. This is used when delta values are simulated, and actual dry aircraft tanks are used for empty.

2.7 DTF measurement

2.7.1 DTF measurement mode

1. Connect CHASSIS jack to Airframe.
2. Turn POWER switch to REV DC (DC+), DC CAP (DC-) or AC CAP. Allow one minute for test set to stabilize.
3. Check battery condition. If "% CHARGE" on the digital display is 10% or less, recharge batteries.
4. Connect TANK UNITS LO Z, HI Z and COMP connectors to the interface box with the appropriate interface cable.
5. Without the aircraft interface connected to the aircraft, place the function select switch in DTF mode.
6. When the unit nulls all stray capacitance, 0pF will be indicated on the units display.

7. Connect the interface to the aircraft and read the capacitance indicated on the units display.
8. Divide the displayed capacitance by the capacitance per foot of the specific coax measured. This number will yield the length of the coax, or the distance to the fault of the coax.

2.8 DVM MEASUREMENT

2.8.1 DVM MEASUREMENT MODE

1. Connect CHASSIS jack to Airframe.
2. Turn POWER switch to REV DC (DC+), DC CAP (DC-) or AC CAP, depending on the system under test. Allow one minute for test set to stabilize.
3. Connect to DVM LO and DVM HI to the interface box with the appropriate interface cable.
4. Turn the FUNCTION SELECT switch to SIMULATE or ground the DVMSEL line in the J1 connector (J1-1 shorted to J1-7).
5. The DC voltage between the DVM HI and DVM LO will be displayed in VDC on the test set display.

2.9 Contaminated Probe

The following sections describe the Contaminated Probe function.

2.9.1 AC/DC Automatic contaminated probe detection

While the test set is performing capacitance measurements, the contaminated probe detector measures current through the fuel probe for the determination of possible microbial growth or other contaminants in the fuel or on the probe. The result of this measurement is shown using a phase error number in the top left of the display, as well as a red LED light to the right of the display.

This measurement is only available in AC CAP and DC CAP (DC-) modes.

A displayed measurement of 0 degrees indicates no phase error, and therefore no detected contamination. Any value greater than 0 degrees indicates that there is a possible contaminated probe. If the measured capacitance is too low for the current range, the test set will not be able to make an accurate phase error measurement and the test set will instead display two dashes in the upper left.

The red LED to the right of the display illuminates when the phase error percentage reaches a set threshold. This threshold defaults to 10% but may be set by the user.

2.9.2 Setting AC/DC Contaminated Probe threshold

Perform the following steps to set the trip point for the Contaminated Fuel Probe LED to illuminate.

1. Press and hold the SIMULATOR FINE knob for 5 seconds.
The current threshold is displayed.
2. Rotate the FINE knob to the desired threshold.
After two seconds of no movement on the knob, the new threshold is saved and the test set displays "DONE".



NOTE

The user setting is retained when the test set power is cycled.

2.9.3 Probe Check measurement

Fuel systems with contaminated fuel or fuel probes will measure different capacitances based on measurement frequency. Probe Check mode varies the frequency from 5000 Hz to 500 Hz, and will display the difference in pF. Additionally, the percentage of error from the displayed capacitance and the capacitance measured at 5000 Hz is displayed in the upper left corner of the display.

Probe Check mode is only valid for AC Fuel systems.

To perform a Probe Check measurement:

1. Connect CHASSIS jack to Airframe.
2. Turn POWER/TYPE SELECT switch to PROBE CHECK.
3. Connect TANK UNITS LO Z, HI Z and COMP connectors to aircraft interface with the appropriate interface cables.
4. Turn FUNCTION SELECT switch to MEASURE EXT/COMP or MEASURE EXT/TU.

The magnitude of the system's TU or COMP is measured at both 5000 Hz and 500 Hz. The absolute value of the difference is displayed in pF on the test set's display. The difference in percent is shown in the top left corner of the display.

2.9.4 Probe Check manual range selection

Perform the following steps to manually select the Probe Check range.

1. Set up the measurement using the Probe Check Measurement procedure.
2. Push the SIMULATOR COARSE switch to select manual range selection. Rotate the SIMULATOR COARSE switch to select the range. Table 2-2 identifies the display indication and the measurement range.

Table 2-2 Display indication and measurement range

Capacitance Range Selection	Display Indication	Capacitance Measurement Range
Auto	Auto pF	0.000 pF - 39.999 KpF (3 ranges)
Low	399.99 pF	0.00 - 399.99
Medium	3999 pF	0.0 pF - 3999.9 pF
High	39999 pF	0 pF - 39999 pF

3. To select the range, rotate through the display indication screens until the screen that is to be selected is displayed. After 2 seconds, the range is selected. If AUTO is selected, repeat Step 2 to change back to the manual range.

2.9.5 Setting Probe Check Contaminated Probe threshold

Perform the following steps to set the trip point for the Contaminated Fuel Probe to illuminate.

1. Press and hold the SIMULATOR FINE knob for 5 seconds.
The current threshold is displayed, in percent.
2. Rotate the FINE knob to the desired threshold.
After two seconds of no movement on the knob, the new threshold is saved and the test set displays "DONE".



NOTE

The user setting is retained when the power is cycled.

2.10 Error codes

Table 2-3 describes the error codes that may be displayed during operation.

Table 2-3 Error Codes

Reading Display	Error Represented
-OR-	Value too big to be measured for current range
-UR-	Value too small to be measured or displayed for current range
-SH- ρ F	LO-Z excitation signal shorted
-SH- Ω	Ohmmeter excitation shorted
CONT	Short for Continue. Press SIMULATOR COARSE to continue.
E001	POWER/TYPE Switch Malfunction
E002	MEG MODE/SIMULATE SELECT Switch Malfunction
E003	FUNCTION Switch Malfunction
E004	MEGGER SELECT Switch Malfunction
E101	Internal Communication Malfunction
E202	Remote command missing or invalid parameter
E203	RS0232 Internal Buffer Overflow

This page intentionally left blank.

Theory of Operations

This chapter provides the theory of operations for the PSD90-3. Topics discussed in this chapter include the following:

- Design architecture 3-36
 - Main board 3-36
 - Display board 3-36
 - IO board 3-36
- Contaminated probe detector 3-36

3.1 Design architecture

The PSD90-3 is constructed with three individual PCBAs that are interconnected. The following sections describe the PCBAs.

3.1.1 Main board

The Main board contains the following functional circuit blocks:

- Capacitance measurements.
- Resistance measurements
- Main microprocessor (PIC)
- Analog to Digital converters
- EEPROM

3.1.2 Display board

The Display board contains the following functional circuit blocks:

- Power supply
- Battery charger
- Simulator capacitor bank
- Simulator Fine Controls Charge Pump
- SIMULATORS COARSE and SIMULATORS FINE multi-functional knob encoders

3.1.3 IO board

The IO BOARD contains the following functional circuit blocks:

- Front panel to main board interconnects

3.2 Contaminated probe detector

The intent of the contaminated probe detector is to measure current through the fuel probe that is resistive in nature, for determination of a possible existence of microbe growth on the probe. While the test set is performing capacitance measurements, the contaminated probe detector measures current through the fuel probe for the determination of possible microbial growth or other contaminants in the fuel or probe. The result of this measurement is shown using a phase error number in the top left of the display, as well as a red LED light to the right of the display.

This measurement is only available in AC CAP and DC CAP (DC-) modes.

The detector measures the current through the fuel probe that is due to the capacitance of the fuel probe, and also measures the current that is due to leakage resistance. The arctangent is performed on the ratio of these currents to get the phase. A pure capacitor will have a phase of 90 degrees, and any deviation from this is displayed in the top left corner in degrees. The degree of error is displayed if the phase error is 1 degree or greater. The contaminated probe LED illuminates when the phase error exceeds the user set trip point.

A displayed measurement of 0 degrees indicates no phase error, and therefore no detected contamination. Any value greater than 0 degrees indicates that there is a possible contaminated probe. If the measured capacitance is too low for the current range, the test set will not be able to make an accurate phase error measurement and the test set will instead display two dashes in the upper left.

The red LED to the right of the display illuminates when the phase error percentage reaches a set threshold. This threshold defaults to 10% but may be set by the user.

This page intentionally left blank.

Maintenance

Maintenance, troubleshooting, and calibration information is provided in the PSD90-3 Maintenance Manual (22166181), available separately from VIAVI.

This page intentionally left blank.

Appendix A: RCI commands

The following sections describe the remote commands supported by the instrument.

A.1 Introduction

You can remotely control and read measurements from the test set using RCI commands.



NOTE

All commands and queries must be terminated in a Carriage Return (0x0D), Line Feed (0x0A), or both.

A.2 RS-232 Setup

To remotely control and read measurements of the test set, connect an RS-232 serial port to J1 of the Test Set. Figure shows an example interface cable.

Figure A-1 Interface cable

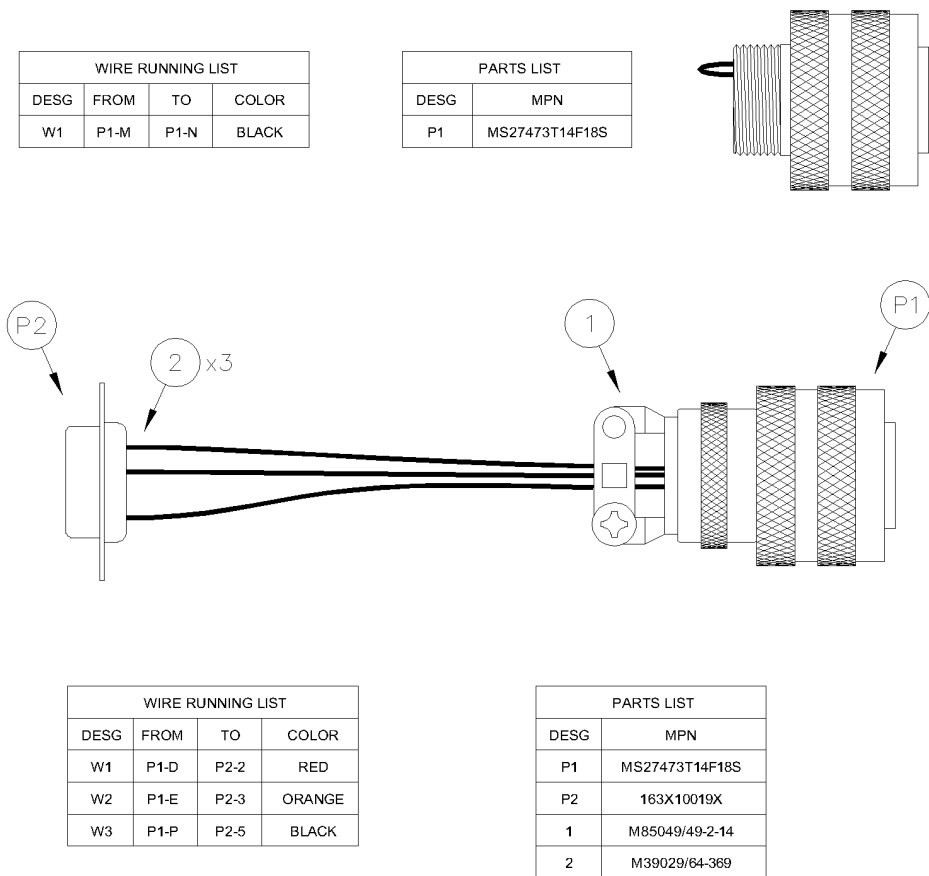

The PSD90-3 uses a standard non-return-to-zero (NRZ) format for RS-232 communication.

The settings are:

- BAUD rate: 9600
- Data: 8 bit
- Parity: None
- Stop: 1 bit
- Flow Control: None

A.3 Common commands

The following sections describe the common commands.

A.3.1 IDN

Command	*IDN?
Description	Command returns the manufacturer, part description, firmware version, and serial number.
Response Example	Viavi Solutions,PSD 90-3,1.003,100

A.3.2 RST

Command	*RST?
Description	A complete reset of the test set, including power-on self-test.

A.3.3 OPC

Command	*OPC
Description	Returns 1 if the last command set has completed; otherwise returns 0.
Response Example	1

A.3.4 TST

Command	*TST?
Description	<p>Returns the results of the power-on self test as a decimal integer. The following values indicate these failures:</p> <ul style="list-style-type: none"> - 0x0000: No Failures - 0x0001: ADC1 - 0x0002: ADC2 - 0x0004: ADC3 - 0x0008: REF - 0x0010: CAP - 0x0020: SLOPE - 0x0040: SCAP - 0x0080: RES - 0x0100: CRC - 0x0200: OPT - 0x0400: UREF - 0x0800: URES - 0x1000: UCAP - 0x2000: PLL - 0x4000: SPI1 - 0x8000: SPI2
Response Example	16

A.4 Front Panel Switch Control

A.4.1 Power/Type Select Switch

Command	:SWITCH:TYPE:SET <switch>
Description	Command will override the current Power/Type Select Switch. The override condition will stay in effect until remote mode is left.
Parameters	<p><switch> The new switch position. The valid values are:</p> <ul style="list-style-type: none"> - OEMDC - REVDC - DC - AC - VARFREQ
Example	:SWITCH:TYPE:SET AC

Command	:SWITCH:TYPE:READ
----------------	-------------------

Description	Command will read physical position of the Power/Type Select Switch.
--------------------	--

Response	<p>The current physical position. This may be different from the current operating position. Returned values:</p> <ul style="list-style-type: none"> – OEMDC – REVDC – DC – AC – VARFREQ – OFF — The unit is reading the switch position as if it is in the OFF state. – INVALID — The unit is not reading a valid switch position.
-----------------	--

Response Example	REVDC
-------------------------	-------

A.4.2 Function Select Switch Control

Command	:SWITCH:FUNC:SET <switch>
----------------	---------------------------

Description	Command will override the current Function Select Switch. The override condition will stay in affect until remote mode is left.
--------------------	---

Parameters	<p><switch> The new switch position. Valid values:</p> <ul style="list-style-type: none"> – COMP – TU – MEGGER – DTF – MEASINT – SIM
-------------------	--

Example	:SWITCH:FUNC:SET MEGGER
----------------	-------------------------

Command	:SWITCH:FUNC:READ?
----------------	--------------------

Description	Command will read the physical position of the Function Select Switch.
--------------------	--

Response	<p>The current physical position. This may be different from the current operating position. Returned values:</p> <ul style="list-style-type: none"> – COMP – TU – MEGGER – DTF – MEASINT – SIM – INVALID — The unit is not reading a valid switch position.
-----------------	---

Response Example	MEASINT
-------------------------	---------

A.4.3 Meg Mode/Simulator Mode Switch Control

Command	:SWITCH:MODE:SET <switch>
Description	Command will override the current Meg Mode/Simulation Mode Switch. The override condition will stay in affect until remote mode is left.
Parameters	<switch> The new switch position. Valid values: <ul style="list-style-type: none">- 2WIRE- 3WIRE- A/C- A/C_TU- TU_COMP- TU_AUX_COMP
Example	:SWITCH:MODE:SET A/C_TU

Command	:SWITCH:MODE:READ?
Description	Command will read the physical position of the Meg Mode/Simulation Mode Switch.
Response	The current physical position of the Meg Mode/Simulation Mode switch. This may be different from the current operating position. Returned values: <ul style="list-style-type: none">- 2WIRE- 3WIRE- A/C- A/C_TU- TU_COMP- TU_AUX_COMP- INVALID — The unit is not reading a valid switch position.
Response Example	MEASINT

A.4.4 Megger Select Switch (ACMODE)

Command	:SWITCH:MEGGER:ACMODE:SET <left>, <right>
Description	Overrides the current Megger Select Switch. Parameters <left> and <right> define the override position. Accepts the AC Mode descriptions of the positions. The override condition stays in effect until remote mode is left.
Parameters	<p><left> Of the two parameters, <left> represents the text on the left side of the "/" on the switch. Valid values:</p> <ul style="list-style-type: none"> - LO-Z - GND - HI-Z - SHIELD - COMP <p><right> Of the two parameters, <right> represents the text on the left side of the "/" on the switch. Valid values:</p> <ul style="list-style-type: none"> - LO-Z - GND - HI-Z - SHIELD - COMP
Example	:SWITCH:MEGGER:ACMODE:SET LO-Z, GND

Command	:SWITCH:MEGGER:ACMODE:READ?
Description	Reads the physical position of the Meg Mode/Simulation Mode Switch.
Response	<p>The current physical position. This may be different from the current operating position. Returned values:</p> <ul style="list-style-type: none"> - LO-Z,SHIELD - LO-Z,HI-Z - SHIELD,HI-Z - HI-Z,SHIELD - LO-Z,GND - SHIELD,GND - GND,HI-Z - LO-Z,COMP - COMP,SHIELD - COMP,HI-Z - GND,COMP - INVALID — The unit is not reading a valid switch position.
Response Example	LO-Z,SHIELD

A.4.5 Megger Select Switch (DCMODE)

Command	:SWITCH:MEGGER:DCMODE:SET <left>, <right>
----------------	---

Description	Overrides the current Megger Select Switch. Parameters <left> and <right> will define the override position. will accept the AC Mode descriptions of the positions. The override condition will stay in effect until remote mode is left.
--------------------	---

Parameters	<left> Of the two parameters, <left> represents the text on the left side of the “/” on the switch. Valid values: <ul style="list-style-type: none">– LO-Z– GND– HI-Z– SHIELD– COMP <right> Of the two parameters, <right> represents the text on the left side of the “/” on the switch. Valid values: <ul style="list-style-type: none">– LO-Z– GND– HI-Z– SHIELD– COMP
-------------------	---

Example	:SWITCH:MEGGER:DCMODE:SET LO-Z, GND
----------------	-------------------------------------

Command	:SWITCH:MEGGER:DCMODE:READ?
----------------	-----------------------------

Description	Command will read the physical position of the Meg Mode/Simulation Mode Switch.
--------------------	---

Response	The current physical position. This may be different from the current operating position. Returned values: <ul style="list-style-type: none">– LO-Z,DC+– LO-Z,DC-– DC+,DC-– DC-,DC+– LO-Z,GND– DC+,GND– GND,DC-– LO-Z,SHIELD– SHIELD,DC+– SHIELD,DC-– GND,SHIELD– INVALID — The unit is not reading a valid switch position.
-----------------	---

Response Example	LO-Z,DC+
-------------------------	----------

A.4.6 Simulator Coarse Switch

Command	:SWITCH:COARSE:PRESS
Description	Simulates a brief press of the Simulator Coarse switch.
Example	:SWITCH:COARSE:PRESS
Command	:SWITCH:COARSE:TURN <counts>
Description	Simulates a rotation of the simulator coarse switch.
Parameters	<counts> How much to simulate the rotation of the switch. Negative is counter-clockwise, positive is clockwise.
Example	:SWITCH:COARSE:TURN -5

A.4.7 Simulator Fine Switch

Command	SWITCH:FINE:PRESS
Description	Simulates a brief press of the Simulator Fine switch.
Example	:SWITCH:COARSE:PRESS
Command	:SWITCH:COARSE:TURN <counts>
Description	Simulates a rotation of the switch.
Parameters	<counts> How much to simulate the rotation of the switch. Negative is counter-clockwise, positive is clockwise.
Example	:SWITCH:FINE:TURN -5

A.5 Capacitance Simulation

The following sections describe the Capacitance Simulation commands.

A.5.1 Capacitance Simulation Value

Command	:CAPSIM:TU:CAP <capacitance>
Description	Sets the current simulated capacitance of the TU simulator in μF .
Parameters	<capacitance> The new capacitance, in μF .
Example	:CAPSIM:CAP 305.2

Command	:CAPSIM:TU:CAP?
Description	Reads the current simulated capacitance of the TU simulator in μF .
Response	The currently set simulated capacitance, in μF .
Response Example	305.2

Command	:CAPSIM:COMP:CAP <capacitance>
Description	Sets the current simulated capacitance of the COMP simulator in μF .
Parameters	<capacitance> The new capacitance, in μF .
Example	CAPSIM:COMP:CAP 305.2

Command	:CAPSIM:COMP:CAP?
Description	Reads the current simulated capacitance of the COMP simulator, in μF .
Response	The currently set simulated capacitance, in μF .
Response Example	305.2

Command	:CAPSIM:AUX:CAP <capacitance>
Description	Command will set the current simulated capacitance of the AUX simulator, in μF .
Parameters	<capacitance> The new capacitance, in μF .
Example	:CAPSIM:AUX:CAP 305.2

Command	:CAPSIM:AUX:CAP?
Description	Command will read the current simulated capacitance of the AUX simulator, in pF.
Response	The currently set simulated capacitance, in pF.
Response Example	305.2

A.5.2 Simulation Mode

Command	:CAPSIM:MEAS:MODE <mode>
Description	Sets the current cap simulator's mode being measured. Only valid when in MEAS INT.
Parameters	<mode> The new capacitance simulation mode. Valid values are: <ul style="list-style-type: none"> - TU: Tank Unit - AUX: Auxiliary - COMP: Comp - TU_AUX: Tank Unit with Auxiliary
Example	:CAPSIM:MODE A/C

Command	:CAPSIM:MEAS:MODE?
Description	Reads the current cap simulator's mode for MEAS INT.
Response	The current capacitance simulation mode being measured.
Response Example	AUX

A.5.3 Calibration

Command	:CAPSIM:CAL:STEP:SET <step>
Description	Sets the current calibration step for the simulator.
Parameters	<step> The calibration step to set the simulator to. Must be a positive integer.
Example	:CAPSIM:CAL:STEP:SET 17

Command	:CAPSIM:CAL:STEP:VALUE <step>, <value>
Description	Command will set the desired step calibration value.
Parameters	<step>The calibration step to set the simulator to. Must be a positive integer. <value>The new calibration value, in femtofarads.
Response Example	:CAPSIM:CAL:STEP:VALUE 17, 398320

Command	:CAPSIM:CAL:STEP:VALUE? <step>
Description	Command will return the current calibration value for the step.
Parameters	<step> The calibration step. Must be a positive integer.
Example	:CAPSIM:CAL:STEP:VALUE? 17
Response Example	398320

Command	:CAPSIM:CAL:WRITEALL
Description	Command will record the calibration step values into the EEPROM. This is the only way to save the calibration data over between power cycles.
Example	CAPSIM:CAL:WRITEALL.

A.6 AC CAP Measure

The following sections describe the AC CAP measure commands.

A.6.1 Measurement range

Command	:ACCAP:RANGE <range>
Description	Command will set the current range of the AC CAP measurement. Will also set the ranging mode to manual.
Parameters	<range> The new range in pF. Must be one of the following: <ul style="list-style-type: none"> – 40 – 400 – 4000 – 40000
Example	:ACCAP:RANGE 4000

Command	:ACCAP:RANGE?
Description	Command will return the current range in pF.
Example	:ACCAP:RANGE?
Response Example	40000

Command	:ACCAP:AUTO <is_auto>
Description	Command sets the current ranging mode for the ACCAP measurement.
Parameters	<is_auto> – 1 for AUTO – 0 for Manual
Example	:ACCAP:AUTO 1

Command	:ACCAP:AUTO?
Description	Command returns the current ranging mode: – 1 for AUTO – 0 for Manual
Example	:ACCAP:AUTO?
Response Example	1

A.6.2 Read measurement

Command	:ACCAP:READ:CAP?
Description	Command returns the most recent reading, in pF.
Response Example	25.251

Command	:ACCAP:READ:PHASE?
Description	Command returns the most recent phase, in degrees..
Response Example	1

A.7 DC CAP Measure

The following sections describe the DC CAP Measure commands.

A.7.1 Measurement Range

Command	:DCCAP:RANGE <range>
Description	Command sets the current range of the DCCAP measurement. Also sets the ranging mode to manual.
Parameters	<range> The new range in pF. Must be one of the following: <ul style="list-style-type: none"> - 40 - 400 - 4000 - 40000
Example	:DCCAP:RANGE 4000
Command	:DCCAP:RANGE?
Description	Command returns the current range, in pF.
Example	:DCCAP:RANGE?
Response Example	40000
Command	:DCCAP:AUTO <is_auto>
Description	Command will set the current ranging mode for the DCCAP measurement.
Parameters	<is_auto> 1 for AUTO, 0 for Manual
Example	DCCAP:AUTO 1
Command	:DCCAP:AUTO?
Description	Returns the current ranging mode. <ul style="list-style-type: none"> - 1: Auto - 0: Manual
Example	:DCCAP:AUTO?
Response Example	1

A.7.2 Read Measurement

Command	:DCCAP:READ:CAP?
Description	Command returns the most recent reading in pF.
Response Example	25.251
Command	:DCCAP:READ:PHASE?
Description	Returns the most recent phase, in degrees.
Response Example	1

A.8 OEMDC Measure

The following sections describe the OEMDC Measure commands.

A.8.1 Measurement Range

Command	:OEMDC:RANGE <range>
Description	Sets the current range of the OEMDC measurement. Also sets the ranging mode to MANUAL.
Parameters	<range> The new range, in pF. Must be one of the following: – 400 – 2000
Example	:OEMDC:RANGE 2000
Command	:OEMDC:RANGE?
Description	Returns the current range, in pF.
Example	:OEMDC:RANGE?
Response Example	400

Command	:OEMDC:AUTO <is_auto>
Description	Sets the current ranging mode for OEMDC measurement.
Parameters	<is_auto> <ul style="list-style-type: none">- 1 for Auto- 0 for Manual
Example	:OEMDC:AUTO 1

Command	:OEMDC:AUTO?
Description	Returns the current ranging mode. <ul style="list-style-type: none">- 1 for Auto- 0 for Manual
Response Example	1

A.8.2 Manufacturer Setting

Command	:OEMDC:MANU: <manu>
Description	Returns the most recent reading, in pF.
Parameters	<manu>
Example	:OEMDC:MANU B

Command	:OEMDC:MANU?
Description	Command will return the current simulated Manufacturer for OEMDC mode.
Response Example	C

A.8.3 Read Measurement

Command	:OEMDC:READ:CAP?
Description	Returns the most recent reading, in pF.
Response Example	25.251

A.9 Probe Check

The following sections describe the Probe Check commands.

A.9.1 Measurement range

Command	:VARFREQ:RANGE <range>
Description	Sets the current range of the Probe Check measurement. Also sets the ranging mode to manual.
Parameters	<range> The new range in pF. Must be: <ul style="list-style-type: none"> – 400 – 4000 – 40000
Example	:VARFREQ:RANGE 4000
Command	:VARFREQ:RANGE?
Description	Returns the current range, in pF.
Example	:VARFREQ:RANGE?
Response Example	400
Command	:VARFREQ:AUTO <is_auto>
Description	Sets the current ranging mode for the OEM DC measurement.
Parameters	<is_auto> <ul style="list-style-type: none"> – 1 for AUTO – 0 for MANUAL
Example	:VARFREQ:AUTO 1
Command	:VARFREQ:AUTO?
Description	Returns the current ranging mode. <ul style="list-style-type: none"> – 1 for AUTO – 0 for MANUAL
Response Example	1

A.9.2 Read Measurements

Command	:VARFREQ:READ:MAG?
Description	Returns the most recent reading, in ρF .
Response Example	25.251

Command	VARFREQ:READ:CAP?
Description	Returns the most recent reading, in ρF .
Response Example	25.251

Command	:VARFREQ:READ:RES?
Description	Returns the most recent reading, in ρF .
Response Example	25.251

Command	:VARFREQ:READ:PHASE?
Description	Returns the most recent reading, in ρF .
Response Example	25.251

A.10 Megger Measurement

The following sections describe the Megger measurement commands.

A.10.1 Measurement Range

Command	:MEGGER:RANGE <range>
Description	Command sets the current range of the MEGGER measurement. Also sets the ranging mode to manual.
Parameters	<range> The new range. Must be one of the following: <ul style="list-style-type: none"> – 40 – 400 – 4k – 40k – 400k – 4M – 40M – 400M – 4G – 20G
Response Example	400K

Command	:MEGGER:RANGE?
Description	Command returns the current range.
Example	:MEGGER:RANGE?
Response Example	400K

Command	:MEGGER:AUTO <is_auto>
Description	Command will set the current ranging mode for the MEGGER measurement.
Parameters	<is_auto> 1 for AUTO 0 for Manual.
Example	:MEGGER:AUTO 1

Command	:MEGGER:AUTO?
Description	Command returns the current ranging mode. 1 for AUTO, 0 for Manual.
Example	:MEGGER:AUTO?
Response Example	1

A.10.2 Read Measurement

Command	:MEGGER:READ:OHM?
Description	Command will return the most recent reading.
Example	:MEGGER:READ:OHM
Response Example	25.432 MOhm

A.11 Distance to Fault

The following sections describe the Distance to Fault commands.

A.11.1 Read Measurement

Command	:DTF:READ?
Description	Returns the most recent distance to fault measurement, in pF.
Response Example	525

A.12 Digital Volt Meter

The following sections describe the Digital Volt Meter commands.

A.12.1 Read Measurement

Command	:DVM:READ?
Description	Returns the most recent digital voltmeter reading, in Volts.
Response Example	5.05



22166183, R001

March 2023

EXPORT CONTROL WARNING: This document contains controlled technology under the jurisdiction of the Export Administration Regulations (EAR), 15 CFR 730-774. It cannot be transferred to any foreign party without appropriate authorization under the EAR. Violations of these regulations are punishable by fine, imprisonment, or both.

VIAVI Solutions

North America: 1.844.GO VIAVI / 1.844.468.4284

Latin America +52 55 5543 6644

EMEA +49 7121 862273

APAC +1 512 201 6534

All Other Regions: [viavisolutions.com/contacts](https://www.viavisolutions.com/contacts)

Address 1445 South Spectrum Blvd., Suite 102, Chandler, AZ, 85286, USA