



Communications Test Set 3500 / 3500A Getting Started Manual

Issue-4

EXPORT CONTROL WARNING: This document contains controlled technology or technical data under the jurisdiction of the Export Administration Regulations (EAR), 15 CFR 730-774. It cannot be transferred to any foreign third party without the specific prior approval of the U.S. Department of Commerce, Bureau of Industry and Security (BIS). Violations of these regulations are punishable by fine, imprisonment, or both.

GETTING STARTED MANUAL

COMMUNICATIONS TEST SET

3500 / 3500A

PUBLISHED BY
Aeroflex

COPYRIGHT © Aeroflex 2011

All rights reserved. No part of this publication may be reproduced, stored in a retrieval system, or transmitted in any form or by any means, electronic, mechanical, photocopying, recording or otherwise without the prior permission of the publisher.

Reissued	Jan 2010
Issue-2	Apr 2010
Issue-3	May 2010
Issue-4	Mar 2011

10200 West York / Wichita, Kansas 67215 U.S.A. / (316) 522-4981 / FAX (316) 524-2623

Subject to Export Control, see Cover Page for details.

This manual contains essential information relating to initial use of the unit.

Aeroflex recommends the operator become familiar with the 3500 / 3500A Operation Manual before attempting to operate the unit.

SAFETY FIRST: TO ALL OPERATIONS PERSONNEL

REFER ALL SERVICING OF UNIT TO QUALIFIED TECHNICAL PERSONNEL. THE 3500 / 3500A CONTAINS NO OPERATOR SERVICEABLE PARTS.

WARNING: USING THIS EQUIPMENT IN A MANNER NOT SPECIFIED BY THE ACCOMPANYING DOCUMENTATION MAY IMPAIR THE SAFETY PROTECTION PROVIDED BY THE EQUIPMENT.

CASE, COVER OR PANEL REMOVAL

Opening the Case Assembly exposes the operator to electrical hazards that can result in electrical shock or equipment damage. Do not operate the 3500 / 3500A with the Case Assembly open.

SAFETY IDENTIFICATION IN TECHNICAL MANUAL

This manual uses the following terms to draw attention to possible safety hazards that may exist when operating or servicing this equipment.

CAUTION: THIS TERM IDENTIFIES CONDITIONS OR ACTIVITIES THAT, IF IGNORED, CAN RESULT IN EQUIPMENT OR PROPERTY DAMAGE (E.G., FIRE).

WARNING: THIS TERM IDENTIFIES CONDITIONS OR ACTIVITIES THAT, IF IGNORED, CAN RESULT IN PERSONAL INJURY OR DEATH.

SAFETY SYMBOLS IN MANUALS AND ON UNITS



CAUTION: Refer to accompanying documents. (This symbol refers to specific CAUTIONS represented on the unit and clarified in the text.)



AC OR DC TERMINAL: Terminal that may supply or be supplied with ac or dc voltage.



DC TERMINAL: Terminal that may supply or be supplied with dc voltage.



AC TERMINAL: Terminal that may supply or be supplied with ac or alternating voltage.

EQUIPMENT GROUNDING PRECAUTION

Improper grounding of equipment can result in electrical shock.

USE OF PROBES

Check the specifications for the maximum voltage, current and power ratings of any connector on the 3500 / 3500A before connecting a probe from a terminal device. Be sure the terminal device performs within these specifications before using a probe for measurement, to prevent electrical shock or damage to the equipment.

POWER CORDS

Power cords must not be frayed, broken nor expose bare wiring when operating this equipment.

USE RECOMMENDED FUSES ONLY

Use only fuses specifically recommended for the equipment at the specified current and voltage ratings.

Subject to Export Control, see Cover Page for details.

SAFETY FIRST: TO ALL OPERATIONS PERSONNEL (cont)

INTERNAL BATTERY

The 3500 / 3500A contains a Lithium Ion Battery, serviceable only by a qualified technician.

CAUTION: SIGNAL GENERATORS CAN BE A SOURCE OF ELECTROMAGNETIC INTERFERENCE (EMI) TO COMMUNICATION RECEIVERS. SOME TRANSMITTED SIGNALS CAN CAUSE DISRUPTION AND INTERFERENCE TO COMMUNICATION SERVICES OUT TO A DISTANCE OF SEVERAL MILES. USERS OF THIS EQUIPMENT SHOULD SCRUTINIZE ANY OPERATION THAT RESULTS IN RADIATION OF A SIGNAL (DIRECTLY OR INDIRECTLY) AND SHOULD TAKE NECESSARY PRECAUTIONS TO AVOID POTENTIAL COMMUNICATION INTERFERENCE PROBLEMS.

TABLE OF CONTENTS

Service upon Receipt of Material	2
Specifications	9
Installation	11
Controls, Connectors and Indicators	15
Screen Icons	19
Screen Hierarchy	21
Self Test	25
Battery/Voltage Instructions	27
Fuse Replacement	31
Battery Replacement	32

SERVICE UPON RECEIPT OF MATERIAL

UNPACKING

Special-design packing material inside this shipping carton provides maximum protection for the 3500 / 3500A. Avoid damaging the carton and packing material during equipment unpacking. Use the following steps for unpacking the 3500 / 3500A.

- Cut and remove the sealing tape on the carton top and open the carton.
- Remove the top packing mold.
- Remove 3500 / 3500A and packing material from bottom packing mold.
- Remove the protective plastic bag from the 3500 / 3500A.
- Place protective plastic bag and packing material inside shipping carton.
- Store the shipping carton for future use should the 3500 / 3500A need to be returned.

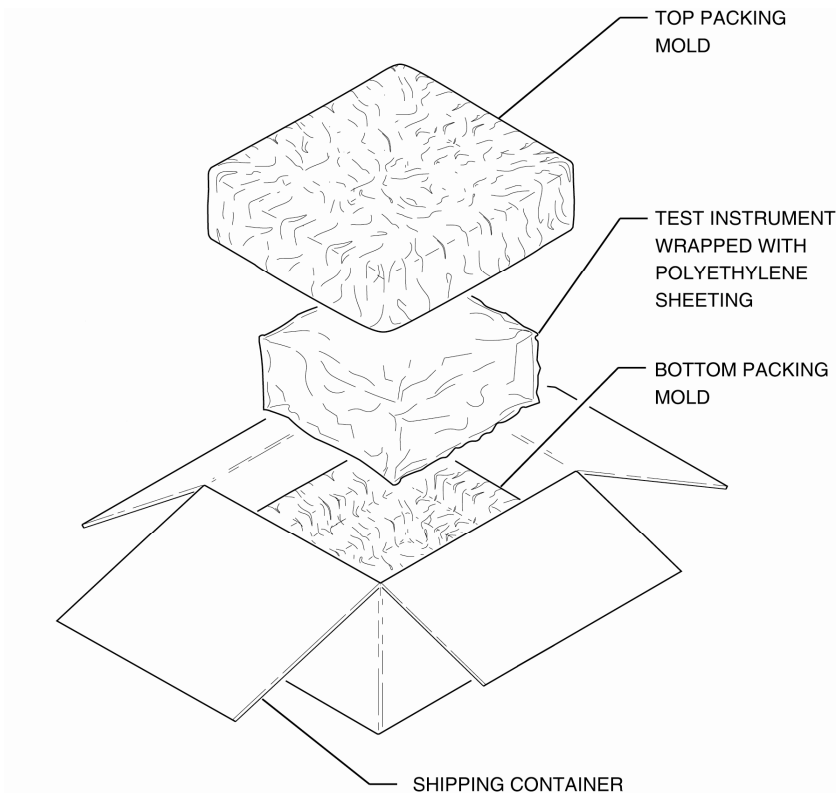

SERVICE UPON RECEIPT OF MATERIAL (cont)

CHECKING UNPACKED EQUIPMENT

- Inspect the equipment for damage incurred during shipment. If the equipment has been damaged, report the damage to Aeroflex.
- Check the equipment against the packing slip to see if the shipment is complete. Report all discrepancies to Aeroflex.

3500 STANDARD ITEMS

DESCRIPTION	PART NUMBER	QTY
3500 Communications Test Set		1
Adapter (BNC-F to TNC-M)	23758 (2200-0410-700)	5
Cable (BNC) (M-M) (48 in)	62368 (6041-4284-400)	2
Cable (TNC) (M-M) (48 in)	62398 (6041-5680-800)	1
Case, Accessory	5763 (1000-6200-800)	1
Case, Soft-Sided Carrying	10191 (1412-0006-006)	1
Comm Breakout Box	64598 (7005-6242-900)	1
External DC Power Supply	67374 (7110-6200-200)	1
Fuse, Spare (5 A, 32 Vdc, Type F)	56080 (5106-0000-057)	2
Handset	64592 (7005-6240-200)	1
Handset Cable	62403 (6041-6280-000)	1
Manual, Getting Started (Paper)	6107 (1002-6200-8P0)	1
Manual, Operation/ICW (CD)	6105 (1002-6200-2C0)	1
Power Cable (AC)	62302 (6041-0001-000)	1
Power Cable (DC Cigarette Lighter)	62404 (6041-6281-400)	1
Short-Open-Load VSWR Calibrator (TNC)	38245 (2901-0000-054)	1

SERVICE UPON RECEIPT OF MATERIAL (cont)



SERVICE UPON RECEIPT OF MATERIAL (cont)

3500A STANDARD ITEMS

DESCRIPTION	PART NUMBER	QTY
3500A Communications Test Set		1
Adapter (BNC-F to TNC-M)	23758 (2200-0410-700)	5
Antenna (BNC) (50 MHz)	9149 (1201-7617-001)	1
Antenna (BNC) (150 MHz)	9145 (1201-7616-801)	1
Antenna (BNC) (450 MHz)	9147 (1201-7616-901)	1
Antenna (BNC) (800 MHz)	9143 (1201-7616-001)	1
Cable (BNC) (M-M) (48 in)	62368 (6041-4284-400)	2
Cable (TNC) (M-M) (48 in)	62398 (6041-5680-800)	1
Case, Accessory	5762 (1000-6200-700)	1
Case, Soft-Sided Carrying	10192 (1412-0006-007)	1
Comm Breakout Box	64598 (7005-6242-900)	1
External DC Power Supply	67374 (7110-6200-200)	1
Fuse, Spare (5 A, 32 Vdc, Type F)	56080 (5106-0000-057)	2
Handset	64606 (7005-6244-700)	1
Manual, Getting Started (Paper)	6107 (1002-6200-8P0)	1
Manual, Operation/ICW (CD)	6105 (1002-6200-2C0)	1
Power Cable (AC) (3-wire leads)	27516 (23424/159)	1
Power Cable (AC) (Continental Europe)	27480 (23422/007)	1
Power Cable (AC) (North America)	27478 (23422/005)	1
Power Cable (AC) (UK)	27477 (23422/002)	1
Power Cable (DC Cigarette Lighter)	62404 (6041-6281-400)	
Short-Open-Load VSWR Calibrator (TNC)	38245 (2901-0000-054)	1
USB Flash Drive (1 GB)	67327 (7110-1100-600)	1

SERVICE UPON RECEIPT OF MATERIAL (cont)



SERVICE UPON RECEIPT OF MATERIAL (cont)

3500 / 3500A OPTIONAL ITEMS
(These optional items may be included if ordered.)

DESCRIPTION	PART NUMBER	QTY	MODEL
Antenna (BNC) (50 MHz)	9149 (1201-7617-001)	1	3500
Antenna (BNC) (150 MHz)	9145 (1201-7616-801)	1	3500
Antenna (BNC) (450 MHz)	9147 (1201-7616-901)	1	3500
Antenna (BNC) (800 MHz)	9143 (1201-7616-001)	1	3500
Attenuator (20 dB / 50 W)	82559 (AC27002)		3500 / 3500A
Attenuator (20 dB / 50 W)	38240 (2901-0000-049)	1	
Adapter (N-F to BNC-F)	23770 (2200-0412-800)	1	
Adapter (N-M to TNC-M)	23766 (2200-0412-400)	1	
Attenuator (20 dB / 150 W)	82560 (AC27003)		3500 / 3500A
Attenuator (20 dB / 150 W)	38242 (2901-0000-051)	1	
Adapter (N-F to BNC-F)	23770 (2200-0412-800)	1	
Adapter (N-M to BNC-F)	20327 (2113-0000-004)	1	
Battery, Spare	67076 (7020-0012-500)	1	3500 / 3500A
Case, Transit	10242 (1412-6200-500)	1	3500 / 3500A
Desk Top Stand	63656 (6500-5681-000)	1	3500 / 3500A
Directional Coupler (20 to 200 MHz)	63964 (AC27013)		3500 / 3500A
Directional Coupler (20 to 200 MHz)	47290 (4100-0900-000)	1	
Attenuator (10 dB)	38255 (2901-0401-010)	1	
Adapter (N-M to BNC-F)	20327 (2113-0000-004)	2	
Cable (BNC) (M-M) (16 in)	62405 (6041-6282-000)	2	
Flip Cover	63966 (7001-6242-100)	1	3500 / 3500A
Maintenance Manual (CD)	6108 (1002-6201-4C0)	1	3500 / 3500A
Tripod	67474 (7112-8102-500)	1	3500 / 3500A
Tripod, Stand, Dolly	67474 (7112-8102-500)	1	3500 / 3500A
	6361 (1005-1000-000)		
	63659 (6500-5881-100)		

SERVICE UPON RECEIPT OF MATERIAL (cont)



(Attenuator, 50 W)



(Attenuator, 150 W)

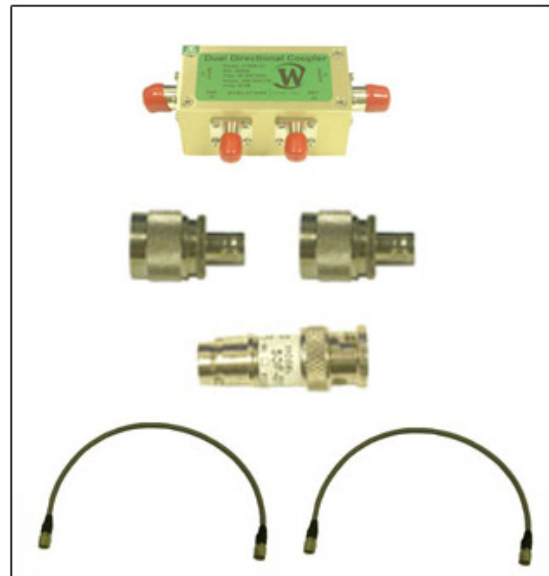

(Directional Coupler)

SPECIFICATIONS

Environmental / Physical

Overall Dimensions:	231 mm (W), 285 mm (L), 70 mm (D) (9.1 in X 11.2 in X 2.8 in)
Weight:	8.5 lbs.; 12 lbs with accessories and soft carrying case
Temperature	
Storage:	-51°C to +71°C Battery must not be subjected to temperatures below -20°C, nor above +60°C
Operation:	-20°C to +55°C
Humidity:	
Storage	Mil-PRF-28800F Class 2
Operation	Mil-PRF-28800F Class 2
Altitude	
Operation	MIL-PRF-28800F, Class 2
Shock, Functional	
Operation	MIL-PRF-28800F, Class 2
Bench Handling	
Operation	MIL-PRF-28800F, Class 2
Vibration	
Operation	MIL-PRF-28800F, Class 2

Compliance / Safety

Use:	Indoors
Pollution Degree:	2
Relative Humidity:	80% minimum for temperatures up to 31°C, decreasing linearly to 50% relative humidity at 40°C.
EMC:	MIL-PRF-28800F, Class 2

AC Input Power

AC Input Voltage Range:	100 to 240 VAC, 1.5 A maximum, 47 Hz to 63 Hz
AC Input Voltage Fluctuation:	<10% of the nominal input voltage
Transient Overvoltage:	According to Installation Category II

SPECIFICATIONS (cont)

AC-DC Converter

Usage Environment:	Indoor Use, Pollution Degree 2
Operating Temperature:	0°C to +40°C
Storage Temperature:	-20°C to +85°C
EMI:	EN55022 Class B, EN61000-3-2 Class D
Safety:	UL 1950, CSA 22.2 No. 234 and No.950, IEC 950/EN 60950

DC Input Power (DC IN Connector)

DC Input Voltage Range:	11 to 32 Vdc
DC Power Input:	25 W Nominal 55 W Maximum
DC Fuse Requirement:	5A, 32 Vdc, Type F

Battery

Battery Type:	Lithium Ion (Li Ion) Battery pack Battery must not be subjected to temperatures below -20°C, nor above +60°C
Operation Time:	5 hours continuous use
Charge Time:	4 hours Battery is to be charged at temperatures between +5°C and +45°C only. Dead Battery (<10% capacity) is to be charged for 20 minutes before operation of AC power.

INSTALLATION

GENERAL

The 3500 / 3500A is powered by an internal Lithium Ion battery pack. The 3500 / 3500A is supplied with an External DC Power Supply which allows the operator to recharge the battery using AC power.

NOTE: The 3500 / 3500A can operate continuously on AC power via the External DC Power Supply, for servicing and/or bench tests.

BATTERY OPERATION

The internal battery is equipped to power the 3500 / 3500A for five hours of continuous use, after which time, the 3500 / 3500A battery needs recharging. When the POWER Indicator is GREEN, the battery is at >25% capacity. When the POWER Indicator is YELLOW, the battery is at <25% capacity.

If the battery level, shown in the BAT Field on most Test Screens, drops to 10 (10%), the 3500 / 3500A powers down automatically.

BATTERY CHARGING

The battery charger operates whenever DC power (11 to 32 Vdc) is applied to the 3500 / 3500A with the supplied External DC Power Supply. When charging, the battery reaches 100% charge in approximately four hours. The internal battery charger allows the battery to charge from 5° to 45°C.

The battery should be charged every three months (minimum) or disconnected for long term inactive storage periods of more than six months. The Battery must be removed when conditions surrounding the Test Set are <-20°C or >60°C.

Allow 20 minutes for the battery to charge when turning 3500 / 3500A ON from a dead battery condition.

SAFETY PRECAUTIONS

The following safety precautions must be observed during installation and operation. Aeroflex assumes no liability for failure to comply with any safety precaution outlined in this manual.

Complying with Instructions

Installation/operating personnel should not attempt to install or operate the 3500 / 3500A without reading and complying with instructions contained in this manual. All procedures contained in this manual must be performed in exact sequence and manner described.

Grounding Power Cord

WARNING: DO NOT USE A THREE-PRONG TO TWO-PRONG ADAPTER PLUG. DOING SO CREATES A SHOCK HAZARD BETWEEN THE CHASSIS AND ELECTRICAL GROUND.

For AC operation, the AC Line Cable, connected to the External DC Power Supply, is equipped with a standard three-prong plug and must be connected to a properly grounded three-prong receptacle. It is the customer's responsibility to:

- Have a qualified electrician check receptacle(s) for proper grounding.
- Replace any standard two-prong receptacle(s) with properly grounded three-prong receptacle(s).

Operating Safety

Due to potential for electrical shock within the 3500 / 3500A, the Case Assembly must be closed when the 3500 / 3500A is connected to an external power source.

Battery replacement, fuse replacement and internal adjustments must only be performed by qualified service technicians.

INSTALLATION (cont)

AC POWER REQUIREMENTS

The External DC Power Supply, supplied with the 3500 / 3500A, operates over a voltage range of 100 to 240 VAC at 47 to 63 Hz.

BATTERY RECHARGING

STEP	PROCEDURE
------	-----------

1. Connect the External DC Power Supply to the DC IN Connector on the 3500 / 3500A.
2. Connect the AC Power Cable to the AC PWR Connector on the External DC Power Supply and an appropriate AC power source
3. Verify the CHARGE Indicator is yellow.
4. Allow four hours for battery charge or until the CHARGE Indicator is green.

NOTE: If the CHARGE Indicator is yellow and/or the battery fails to accept a charge and the 3500 / 3500A does not operate on battery power, the battery, serviceable only by a qualified technician, requires replacement. Refer to Battery/Voltage Instructions.

NOTE: The 3500 / 3500A may turn OFF whenever the External DC Power Supply (connected to AC power) is plugged into the 3500 / 3500A. This is a design behavior to prevent damage to the lithium batteries. Performing the Steps above in order shown helps to avoid the inadvertent turning OFF of the 3500 / 3500A when the External DC Power Supply is connected.

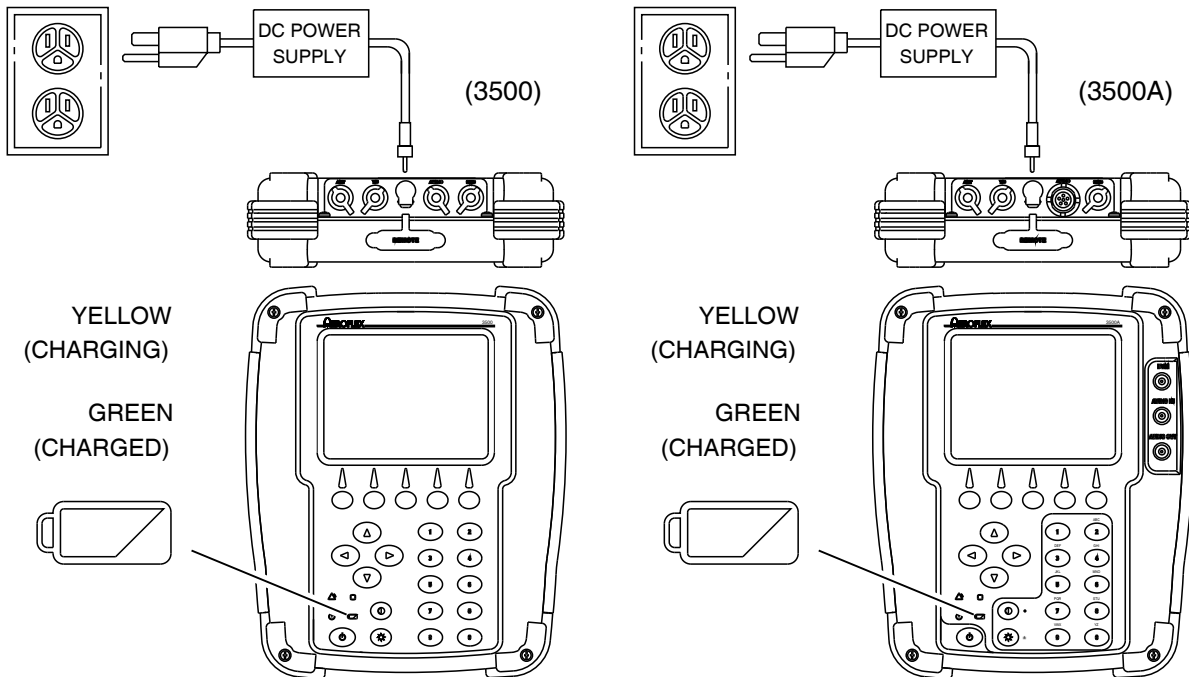

062-001b

INSTALLATION (cont)

EXTERNAL CLEANING

The following procedure contains routine instructions for cleaning the outside of the 3500 / 3500A.

CAUTION: DISCONNECT POWER FROM 3500 / 3500A TO AVOID POSSIBLE DAMAGE TO ELECTRONIC CIRCUITS.

STEP	PROCEDURE
1.	Clean front panel buttons and display face with soft lint-free cloth. If dirt is difficult to remove, dampen cloth with water and a mild liquid detergent.
2.	Remove grease, fungus and ground-in dirt from surfaces with soft lint-free cloth dampened (not soaked) with isopropyl alcohol.
3.	Remove dust and dirt from connectors with soft-bristled brush.
4.	Cover connectors, not in use, with suitable dust cover to prevent tarnishing of connector contacts.
5.	Clean cables with soft lint-free cloth.
6.	Paint exposed metal surface to avoid corrosion.

THIS PAGE INTENTIONALLY LEFT BLANK.

CONTROLS, CONNECTORS AND INDICATORS

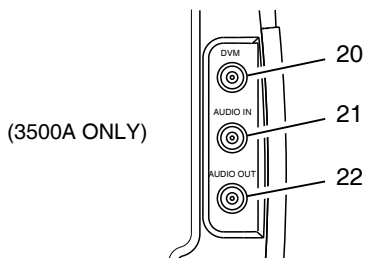
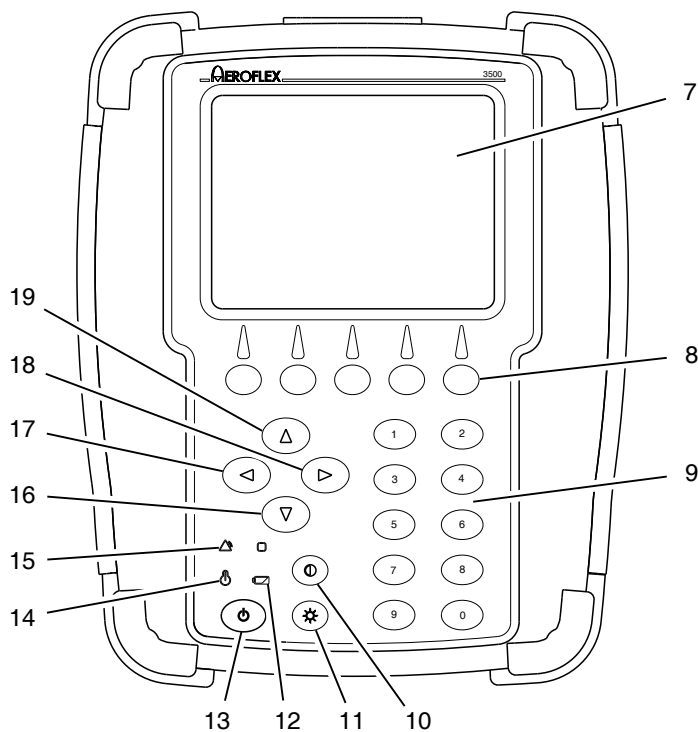
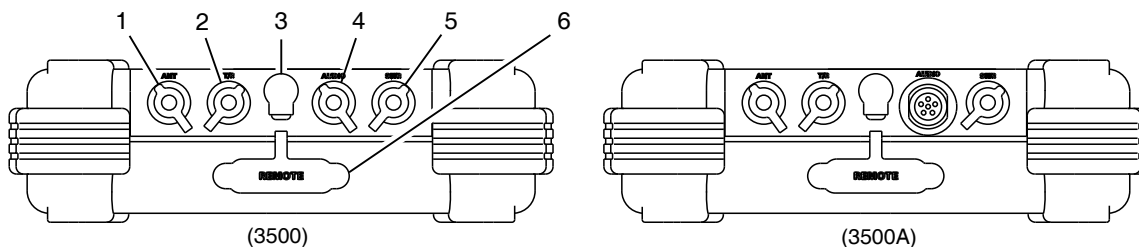

- 1 ANT Connector
- 2 T/R Connector
- 3 DC IN Connector
- 4 AUDIO Connector
- 5 SWR Connector
- 6 REMOTE Connector
- 7 Display (LCD)
- 8 Multi-Function Soft Keys
- 9 Number Keys
- 10 CONTRAST / • Key
- 11 BACKLIGHT / ± Key
- 12 CHARGE Indicator
- 13 POWER Key
- 14 POWER Indicator
- 15 FAULT Indicator
- 16 ▼ DOWN Key
- 17 ◀ LEFT Key
- 18 ▶ RIGHT Key
- 19 ▲ UP Key
- 20 DVM Connector
- 21 AUDIO IN Connector
- 22 AUDIO OUT Connector

062-006b

CONTROLS, CONNECTORS AND INDICATORS (cont)

ITEM	DESCRIPTION
◀ LEFT Key	Used to move the on-screen cursor from one frame to another. Also used to move the on-screen cursor to the next digit to the left in an edit field. NOTE: The on-screen cursor moves in a fixed order. This is to ensure that all frames and fields are accessed in a predictable fashion.
▶ RIGHT Key	Used to move the on-screen cursor from one frame to another. Also used to move the on-screen cursor to the next digit to the right in an edit field. NOTE: The on-screen cursor moves in a fixed order. This is to ensure that all frames and fields are accessed in a predictable fashion.
▲ UP Key	Used to move the on-screen cursor from one field to another within a frame. Also used to increment an edit field. NOTE: The on-screen cursor moves in a fixed order. This is to ensure that all frames and fields are accessed in a predictable fashion.
▼ DOWN Key	Used to move the on-screen cursor from one field to another within a frame. Also used to decrement an edit field. NOTE: The on-screen cursor moves in a fixed order. This is to ensure that all frames and fields are accessed in a predictable fashion.
AUDIO Connector	Used for connection to the Microphone.
AUDIO IN Connector (3500A only)	Used to receive external modulation input, and as input for the SINAD and Distortion Meters and AF Counter.
AUDIO OUT Connector (3500A only)	Used as output for Demod and Function Generators and for Audio In signal output.
ANT Connector	Used for over-the-air tests.
BACKLIGHT / ± Key	Used for selecting the Backlight Adjust Mode. The ▲ UP or ▼ DOWN Keys may be used to adjust the Backlight level. Used to change between positive (+) and negative (-) values during data entry.
CHARGE Indicator	Illuminates when external DC power is applied: GREEN Battery at Full Charge YELLOW Battery is Charging RED Battery Charge Failure

CONTROLS, CONNECTORS AND INDICATORS (cont)





ITEM	DESCRIPTION
CONTRAST / • Key	Used for selecting the Contrast Adjust Mode. The ▲ UP or ▼ DOWN Keys may be used to adjust the Contrast level. Used to add a decimal point (•) to values during data entry.
DC IN Connector	Used for operation of the 3500 / 3500A or battery charging.
Display (LCD)	Used for viewing menus and screens. Soft Key boxes appear at the bottom of the menus/screens.
DVM Connector (3500A only)	Not Used
FAULT Indicator	Illuminates when a fault exists in the 3500 / 3500A: YELLOW Caution Condition exists RED Warning Condition exists
Multi-Function Soft Keys	Five Soft Keys are provided. The legends are displayed in boxes at the bottom of the Display.
Number Keys	Used for data entry or to select a numbered item. Alternate key functions are utilized when selecting file names in the Save Screen.
POWER Indicator	Illuminates when the 3500 / 3500A is powered up.
POWER Key	Used for powering the 3500 / 3500A ON and OFF.
REMOTE Connector (External I/O)	Used for communicating with external equipment.
SWR Connector	Used for measuring the VSWR of Antenna systems. Also used as a transmit signal output.
T/R Connector	Used for high power direct connection to radio equipment.

THIS PAGE INTENTIONALLY LEFT BLANK.

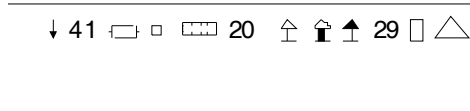



SCREEN ICONS

The screen icons are displayed at the top left of the test screens.



ICON	FUNCTION
	<p>PPC CPU Usage</p> <p>Displays the level of PPC usage.</p> <p>When the PPC usage is 20% to 39%, the icon is displayed as horizontal bar.</p> <p>When the PPC usage is 40% to 59%, the icon is displayed as horizontal bar and vertical bar.</p> <p>When the PPC usage is 60% to 79%, the icon is displayed as horizontal bar and two vertical bars.</p> <p>When the PPC usage is 80% to 100%, the icon is displayed as horizontal bar and three vertical bars. The icon blinks when the PPC usage is >90%.</p>
<p style="text-align: center; font-size: 24pt;">NUMBER</p>	<p>Internal Temperature</p> <p>Displays the current FPGA temperature in °C. (Example: 41)</p> <p>When the internal temperature is <-20°C or >85°C, a warning message is displayed.</p>
	<p>Flash Save Status</p> <p>Displays the status of a save operation.</p> <p>When the icon is fully drawn, all settings are currently saved to Flash. Afer editing, the lower right half of the icon disappears until the settings are saved to Flash.</p>
	<p>Phase Loop Lock (PLL)</p> <p>Displays the status of the Generator and Receiver Synthesizer Lock.</p> <p>Under normal conditions, the icon is displayed as a square.</p> <p>If the Generator becomes unlocked, a warning message is displayed and a triangle shape is displayed (blinking) above the square icon.</p> <p>If the Receiver becomes unlocked, a warning message is displayed and a triangle shape is displayed (blinking) below the square icon.</p>
	<p>Battery Level Indicator</p> <p>Displays the percentage of the battery life remaining.</p> <p>When battery level is <20 (on a 0 to 100 scale) the battery level icon blinks.</p>

SCREEN ICONS (cont)

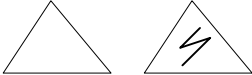
ICON	FUNCTION
NUMBER	<p>Battery Temperature</p> <p>Displays the Battery temperature in °C. (Example: 20)</p> <p>If the battery temperature is >53°C a warning message is displayed and the battery level icon blinks.</p>
	<p>ANT Connector Overload</p> <p>Indicates if the ANT Connector is in overload mode.</p> <p>If the ANT Connector is in overload mode, a warning message is displayed and the lower half of the icon blinks.</p>
	<p>T/R Connector Overload</p> <p>Indicates if the T/R Connector is in overload mode.</p> <p>If the T/R Connector is in overload mode, a warning message is displayed and the lower half of the icon blinks.</p>
	<p>SWR Connector Overload</p> <p>Indicates if the SWR Connector is in overload mode.</p> <p>If the SWR Connector is in overload mode, a warning message is displayed and the lower half of the icon blinks.</p>
NUMBER	<p>RF Temperature</p> <p>Displays the T/R Connector temperature in °C. (Example: 29)</p> <p>The RF temperature increases when more RF power is dissipated.</p>
	<p>AGC Compression</p> <p>Displays the level of Receiver compression.</p> <p>With no AGC compression the icon is displayed as a box.</p> <p>When AGC is in compression, a message is displayed and the icon is displayed as an hourglass.</p>
	<p>DVM Overload</p> <p>Displays the DVM Overload status.</p> <p>When conditions are normal the icon is displayed as a triangle.</p> <p>When an overload occurs, a message is displayed, the icon is displayed as a lightning bolt inside a triangle and the icon blinks.</p>

SCREEN HIERARCHY

The operation mode screen hierarchy is as follows.

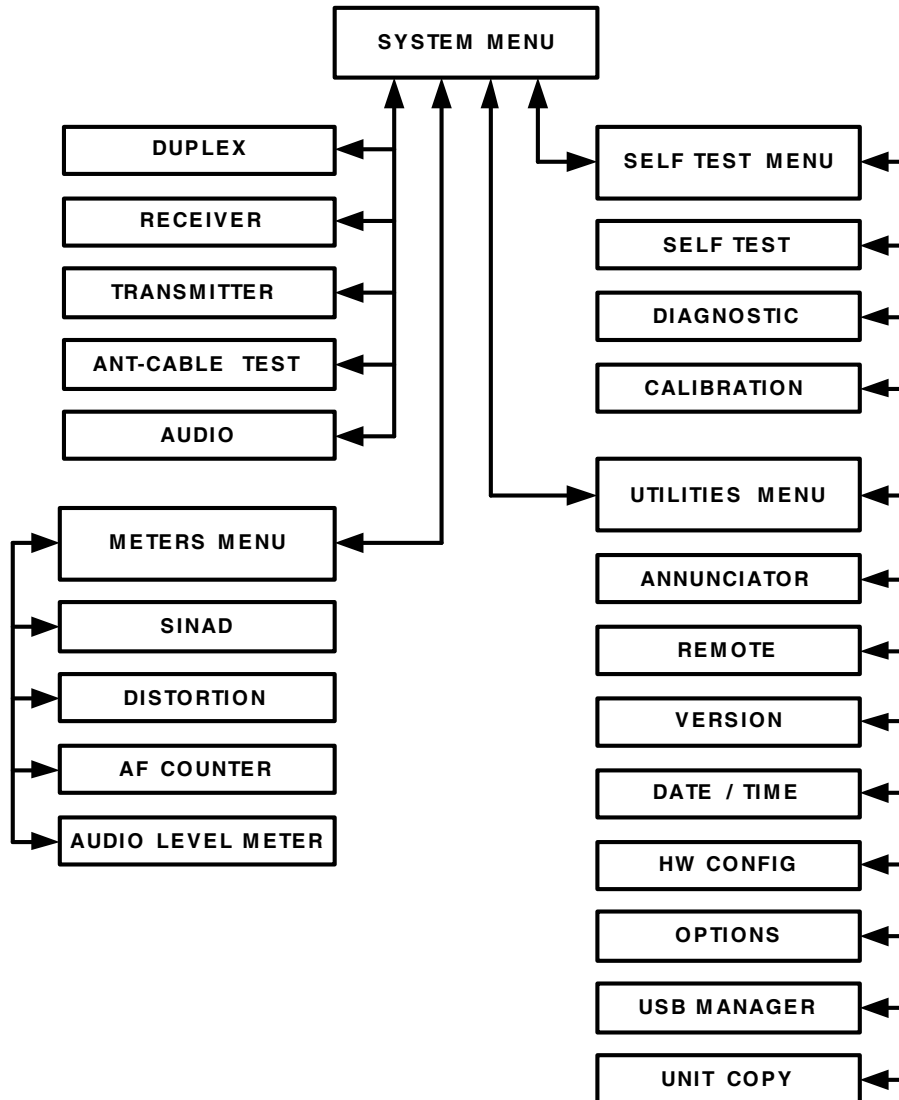

SCREEN HIERARCHY (cont)

System Menu

<p>1 - DUPLEX TEST 2 - RECEIVER TEST 3 - TRANSMITTER TEST 4 - ANT-CABLE TEST 5 - AUDIO</p>				
	Meters	System	Selftest	Util

ANT-Cable Test Screen

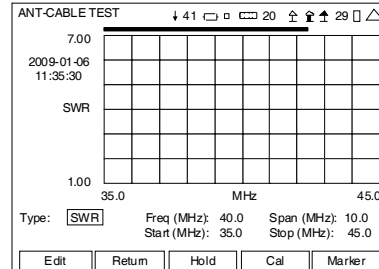

Duplex Test Screen

DUPLEX TEST

Generator Off	Receiver More
MHz: <u>40.000000</u>	MHz: 40.000000
Port: T/R	Port: T/R
Level: -70 dBm	Mod: FM 10k
Ext Attn dB: 0	AFBW: 0.3k HP

Modulator	Freq	FM	Analog
Gen 1: On	1000.0 Hz	6.25 kHz	
Gen 2: On	150.0 Hz	3.25 kHz	
MIC: On		6.25 kHz	
Ext Aud: Off	Load: High Z		

Volume: 100
Squelch: -50 dBm
Speaker: Audio In
AudOut: Audio In
Save Recall

Edit Return Hold Setup PTT on

Audio Test Screen

AF GEN

Function Generator	Freq	Level
# 1: <u>On</u>	1000.0 Hz	1.00 Vrms
# 2: On	2400.0 Hz	1.00 Vrms

Volume: 100
Squelch: -50 dBm
Speaker: Audio In
AudOut: Audio In
Save Recall

Edit Return Hold Setup

Receiver Test Screen

RECEIVER TEST

Generator Off	Receiver More
MHz: <u>40.000000</u>	MHz: 40.000000
Port: T/R	Port: T/R
Level: -70 dBm	Mod: FM 10k
Ext Attn dB: 0	AFBW: 0.3k HP

Modulator	Freq	FM	Analog
Gen 1: On	1000.0 Hz	6.25 kHz	
Gen 2: On	150.0 Hz	3.25 kHz	
MIC: On		6.25 kHz	
Ext Aud: Off	Load: High Z		

Volume: 100
Squelch: -50 dBm
Speaker: Audio In
AudOut: Audio In
Save Recall

Edit Return Hold Setup

Meters Menu

<p>1 - SINAD 2 - DISTORTION 3 - AF COUNTER 4 - AUDIO LEVEL METER</p>	
	Meters System Selftest Util

Transmitter Test Screen

TRANSMITTER TEST

Receiver More
MHz: <u>40.000000</u>
Port: T/R
Mod: FM 10k
AFBW: None

Volume: 100
Squelch: -50 dBm
Speaker: Audio In
AudOut: Audio In
Save Recall

Edit Return Hold Setup

SINAD Meter Screen

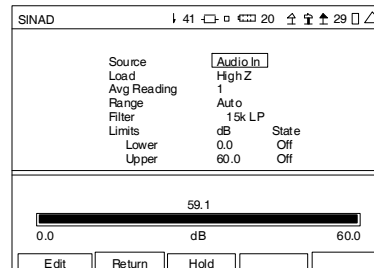

SCREEN HIERARCHY (cont)

Distortion Meter Screen

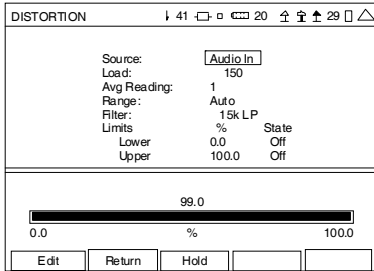

Self Test Screen

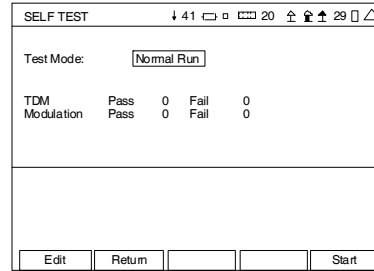

AF Counter Screen

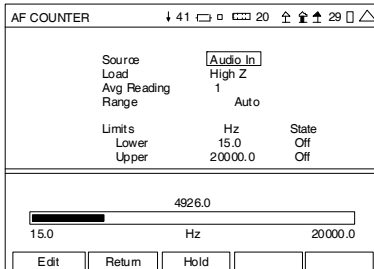

Diagnostics Screen

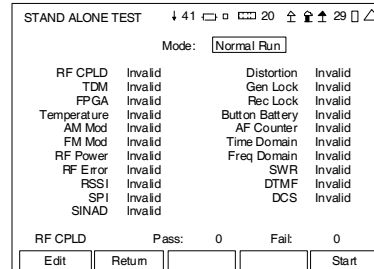

Audio Level Meter Screen

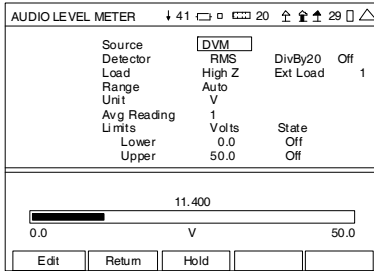

Calibration Screen

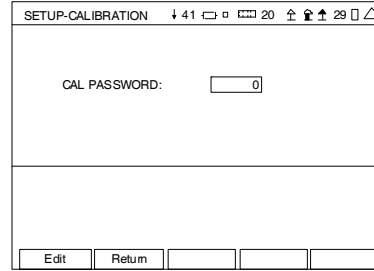

Self Test Menu

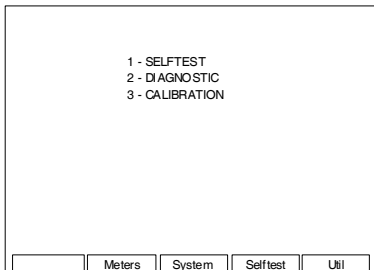

Utilities Menu

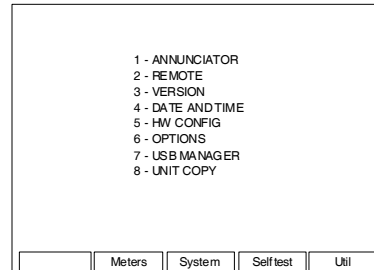

SCREEN HIERARCHY (cont)

Annunciator Screen

ANNUNCIATOR	
Alarm:	<input type="checkbox"/> On
Key Press:	<input type="checkbox"/> Off
PTT:	<input type="checkbox"/> Off
<input type="button" value="Edit"/> <input type="button" value="Return"/>	

HW Config Screen

HW-CONFIG	
Save-Recall:	<input type="button" value="Restore to Default"/>
Scripting:	Auto Exec: Off
Time-Out Timer:	State: On
Minutes:	20
Minutes Remaining:	20
Frequency Find:	Threshold (dBm): -30.0
Ch Spacing (kHz):	12.50
Start Freq (MHz):	2.0
Stop Freq (MHz):	1000.0
<input type="button" value="Edit"/> <input type="button" value="Return"/>	

Remote Setup Screen

REMOTE	
Config Port:	<input type="text" value="ETHERNET"/>
IP:	10 10 10 193
Subnet Mask:	255 0 0 0
Gateway:	0 0 0 0
Ethernet Port:	9991
Ethernet Type:	STANDARD
Port Currently Active:	ETHERNET
<input type="button" value="Edit"/> <input type="button" value="Return"/> <input type="button" value="Config"/>	

Options Screen

OPTIONS	
Install Status:	Installed
Unique ID:	820902c346237d0d
<input type="button" value="Return"/> <input type="button" value="Install"/>	

Version Screen

VERSION	
CFM:	Release-3_8_0:17-FEB-11
PPC:	Release-3_8_0:17-FEB-11
FPGA:	2.0.53:17-Feb-11
MFIO:	2
RF:	0x1
digital CPLD:	7.0.21
RF CPLD:	0x93
HW CPLD:	0x0
U-Boot:	1.02.01.01
Collis:	3.10.0.0.0
MAC Address:	00:50:31:09:00:00
SERIAL:	301000106
<input type="button" value="Return"/>	

USB Manager Screen

USB-MANAGER	
<input type="button" value="All Screen Settings"/>	
Screenshots	Erase from unit
Report File	Erase from unit
Status:	Ready
<input type="button" value="Return"/> <input type="button" value="Save"/> <input type="button" value="Recall"/>	

Date/Time Screen

DATE/TIME	
Current Date:	Friday, 07:44:16, 17-Jul-2009
New Date (DMY):	<input type="text" value="17"/> JUL 2009
New Time (HMS):	<input type="text" value="6"/> <input type="text" value="44"/> <input type="text" value="2"/>
Cal Due Date:	25-JUN-2010
Active Time:	11 Days, 8 Hr, 46 Min, 20 Sec
<input type="button" value="Edit"/> <input type="button" value="Return"/>	

Unit Copy Screen

UNIT COPY	
Unit IP addr:	<input type="text" value="10.10.10.193"/>
Target IP addr:	<input type="text" value="10.10.10.193"/>
Status:	Ready
<input type="button" value="All Screen Settings Clear and Copy"/> <input type="button" value="All Screen Settings Copy"/>	
<input type="button" value="Edit"/> <input type="button" value="Return"/>	

SELF TEST

The 3500 / 3500A is equipped with a Self Test for quick performance evaluation. The Self Test can be performed in a single pass or looped for more consistent results. Test results are shown next to the tests in the Pass/Fail Counters.

STEP	PROCEDURE
------	-----------

1. On the System Menu, Meters Menu or Utilities Menu, press the **F4 "Selftest" Key** to display the Self Test Menu.

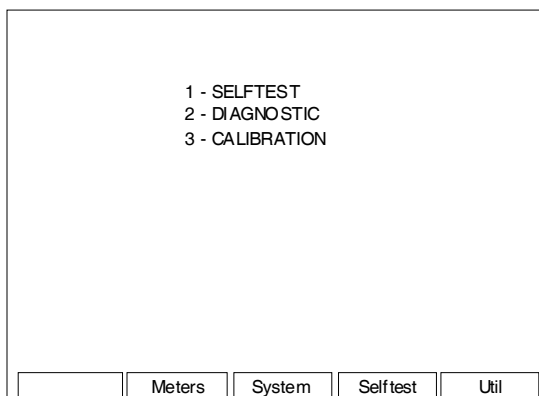

2. With the Self Test Menu displayed, press the **1 Key** to display the Self Test Screen.

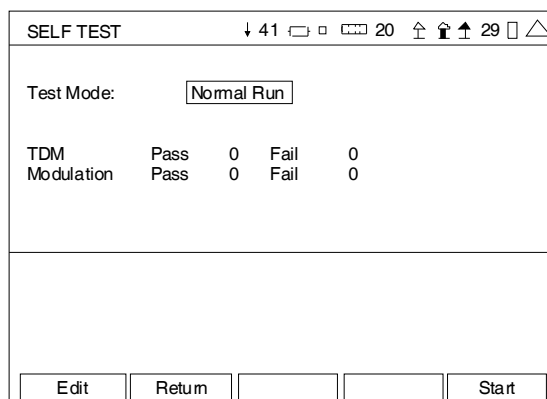

3. Press the **F5 "Start" Key** to initiate the Self Test.
4. Verify the Self Test passes. If any failure occurs, refer to the 3500 / 3500A Operation Manual for more information.

THIS PAGE INTENTIONALLY LEFT BLANK.

**FOR QUALIFIED SERVICE
PERSONNEL ONLY**

BATTERY/VOLTAGE INSTRUCTIONS

THIS PAGE INTENTIONALLY LEFT BLANK.

SAFETY FIRST: TO ALL SERVICE PERSONNEL

REFER ALL SERVICING OF THE 3500 / 3500A TO QUALIFIED TECHNICAL PERSONNEL.

WARNING: USING THIS EQUIPMENT IN A MANNER NOT SPECIFIED BY THE ACCOMPANYING DOCUMENTATION MAY IMPAIR THE SAFETY PROTECTION PROVIDED BY THE EQUIPMENT.

CASE, COVER OR PANEL REMOVAL

Opening the Case Assembly exposes the operator to electrical hazards that can result in electrical shock or equipment damage. Do not operate the 3500 / 3500A with the Case Assembly open.

SAFETY IDENTIFICATION IN TECHNICAL MANUAL

This manual uses the following terms to draw attention to possible safety hazards that may exist when operating or servicing this equipment.

CAUTION: THIS TERM IDENTIFIES CONDITIONS OR ACTIVITIES THAT, IF IGNORED, CAN RESULT IN EQUIPMENT OR PROPERTY DAMAGE (E.G., FIRE).

WARNING: THIS TERM IDENTIFIES CONDITIONS OR ACTIVITIES THAT, IF IGNORED, CAN RESULT IN PERSONAL INJURY OR DEATH.

SAFETY SYMBOLS IN MANUALS AND ON UNITS



CAUTION: Refer to accompanying documents. (This symbol refers to specific CAUTIONS represented on the unit and clarified in the text.)



AC OR DC TERMINAL: Terminal that may supply or be supplied with ac or dc voltage.



DC TERMINAL: Terminal that may supply or be supplied with dc voltage.



AC TERMINAL: Terminal that may supply or be supplied with ac or alternating voltage.

EQUIPMENT GROUNDING PRECAUTION

Improper grounding of equipment can result in electrical shock.

USE OF PROBES

Check the specifications for the maximum voltage, current and power ratings of any connector on the 3500 / 3500A before connecting a probe from a terminal device. Be sure the terminal device performs within these specifications before using a probe for measurement, to prevent electrical shock or damage to the equipment.

POWER CORDS

Power cords must not be frayed, broken nor expose bare wiring when operating this equipment.

USE RECOMMENDED FUSES ONLY

Use only fuses specifically recommended for the equipment at the specified current and voltage ratings.

SAFETY FIRST: TO ALL SERVICE PERSONNEL (cont)

WARNING: THE 3500 / 3500A USES A LITHIUM ION BATTERY PACK. THE FOLLOWING WARNINGS CONCERNING LITHIUM ION BATTERIES MUST BE HEEDED:

- DO NOT RECHARGE OUTSIDE THE 3500 / 3500A.
- DO NOT CRUSH, INCINERATE OR DISPOSE OF IN NORMAL WASTE.
- DO NOT SHORT CIRCUIT OR FORCE DISCHARGE AS THIS MIGHT CAUSE THE BATTERY TO VENT, OVERHEAT OR EXPLODE.

CAUTION: INTEGRATED CIRCUITS AND SOLID STATE DEVICES SUCH AS MOS FETS, ESPECIALLY CMOS TYPES, ARE SUSCEPTIBLE TO DAMAGE BY ELECTROSTATIC DISCHARGES RECEIVED FROM IMPROPER HANDLING, THE USE OF UNGROUNDED TOOLS AND IMPROPER STORAGE AND PACKAGING. ANY MAINTENANCE TO THIS UNIT MUST BE PERFORMED WITH THE FOLLOWING PRECAUTIONS:

- BEFORE USE IN A CIRCUIT, KEEP ALL LEADS SHORTED TOGETHER EITHER BY THE USE OF VENDOR-SUPPLIED SHORTING SPRINGS OR BY INSERTING LEADS INTO A CONDUCTIVE MATERIAL.
- WHEN REMOVING DEVICES FROM THEIR CONTAINERS, GROUND THE HAND BEING USED WITH A CONDUCTIVE WRISTBAND.
- TIPS OF SOLDERING IRONS AND/OR ANY TOOLS USED MUST BE GROUNDED.
- DEVICES MUST NEVER BE INSERTED INTO NOR REMOVED FROM CIRCUITS WITH POWER ON.
- PC BOARDS, WHEN TAKEN OUT OF THE SET, MUST BE LAID ON A GROUNDED CONDUCTIVE MAT OR STORED IN A CONDUCTIVE STORAGE BAG. REMOVE ANY BUILT-IN POWER SOURCE, SUCH AS A BATTERY, BEFORE LAYING PC BOARDS ON A CONDUCTIVE MAT OR STORING IN A CONDUCTIVE BAG.
- PC BOARDS, IF BEING SHIPPED TO THE FACTORY FOR REPAIR, MUST BE PACKAGED IN A CONDUCTIVE BAG AND PLACED IN A WELL-CUSHIONED SHIPPING CONTAINER.

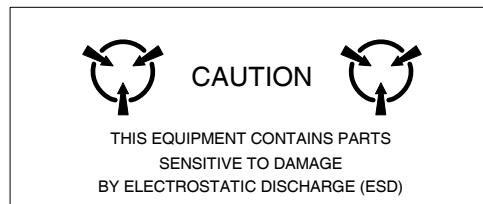

CAUTION: SIGNAL GENERATORS CAN BE A SOURCE OF ELECTROMAGNETIC INTERFERENCE (EMI) TO COMMUNICATION RECEIVERS. SOME TRANSMITTED SIGNALS CAN CAUSE DISRUPTION AND INTERFERENCE TO COMMUNICATION SERVICES OUT TO A DISTANCE OF SEVERAL MILES. USERS OF THIS EQUIPMENT SHOULD SCRUTINIZE ANY OPERATION THAT RESULTS IN RADIATION OF A SIGNAL (DIRECTLY OR INDIRECTLY) AND ENSURE COMPLIANCE WITH INSTRUCTIONS IN FAA CIRCULAR AC 170-6C, DATED FEBRUARY 19, 1981.

FOR QUALIFIED SERVICE PERSONNEL ONLY

FUSE REPLACEMENT

STEP	PROCEDURE
------	-----------

1. Verify the 3500 / 3500A is OFF and not connected to AC power.
2. Fully loosen two captive screws in each of the two lower bumpers and remove the bumpers.
3. Fully loosen five captive screws and lift the Battery Cover from the Case Assembly.
4. Replace fuse:

5 A, 32 Vdc, Type F
(Mini Blade Fuse)
(Aeroflex PN: 56080 [5106-0000-057])

CAUTION: FOR CONTINUOUS PROTECTION AGAINST FIRE, REPLACE ONLY WITH FUSES OF THE SPECIFIED VOLTAGE AND CURRENT RATINGS.

5. Install the Battery Cover on the Case Assembly and tighten the five captive screws (8 in/lbs.).
6. Install the two lower bumpers and tighten the two captive screws in each bumper (8 in/lbs.).

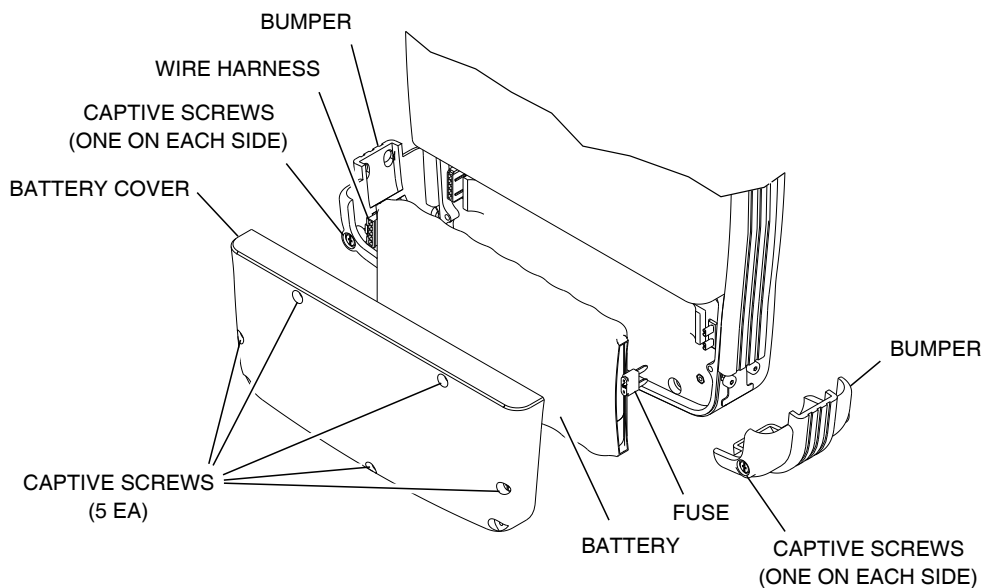

FOR QUALIFIED SERVICE PERSONNEL ONLY

BATTERY REPLACEMENT

STEP	PROCEDURE
------	-----------

1. Verify the 3500 / 3500A is OFF and not connected to AC power.
2. Fully loosen two captive screws in each of the two lower bumpers and remove the bumpers.
3. Fully loosen five captive screws and lift the Battery Cover from the Case Assembly.
4. Disconnect the wire harness connecting the battery to the Test Set and remove the battery.
5. Install new battery and reconnect the wire harness.
6. Install the Battery Cover on the Case Assembly and tighten the five captive screws (8 in/lbs.).
7. Install the two lower bumpers and tighten the two captive screws in each bumper (8 in/lbs.).

WARNING: DISPOSE OF OLD BATTERY ACCORDING TO LOCAL STANDARD SAFETY PROCEDURES.

CAUTION: REPLACE ONLY WITH THE BATTERY SPECIFIED BY AEROFLEX. DO NOT ATTEMPT TO INSTALL A NON-RECHARGEABLE BATTERY.

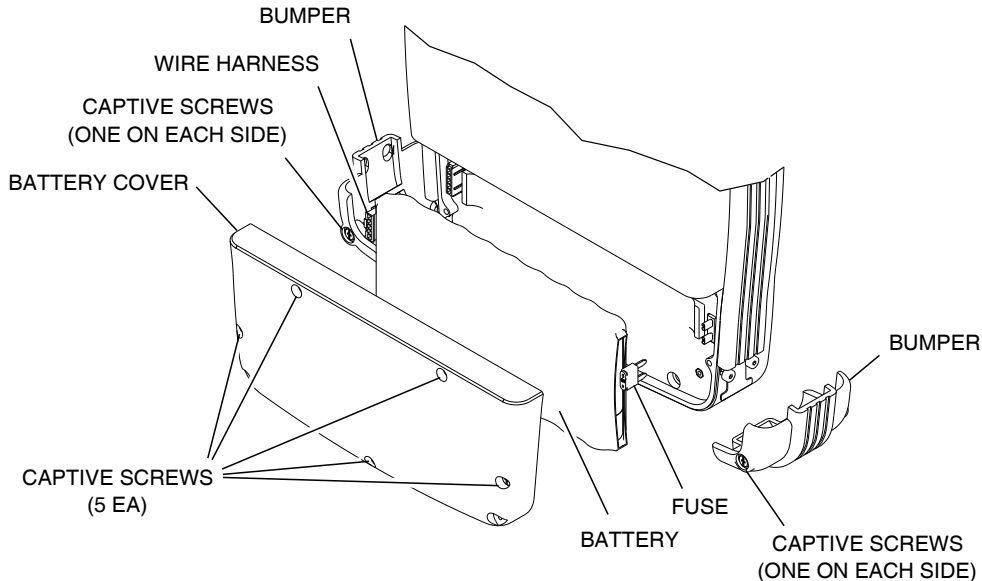

As we are always seeking to improve our products, the information in this document gives only a general indication of the product capacity, performance and suitability, none of which shall form part of any contract. We reserve the right to make design changes without notice.

CHINA / Beijing	Tel: [+86] (10) 6539 1166	Fax: [+86] (10) 6539 1778
CHINA / Shanghai	Tel: [+86] (21) 5109 5128	Fax: [+86] (21) 6457 7668
FINLAND	Tel: [+358] (9) 2709 5541	Fax: [+358] (9) 804 2441
FRANCE	Tel: [+33] 1 60 79 96 00	Fax: [+33] 1 60 77 69 22
GERMANY	Tel: [+49] 8131 2926-0	Fax: [+49] 8131 2926-130
HONG KONG	Tel: [+852] 2832 7988	Fax: [+852] 2834 5364
INDIA	Tel: [+91] (0) 80 4115 4501	Fax: [+91] (0) 80 4115 4502
JAPAN	Tel: [+81] 3 3500 5591	Fax: [+81] 3 3500 5592
KOREA	Tel: [+82] (2) 3424 2719	Fax: [+82] (2) 3424 8620
SCANDINAVIA	Tel: [+45] 9614 0045	Fax: [+45] 9614 0047
*SINGAPORE	Tel: [+65] 6873 0991	Fax: [+65] 6873 0992
SPAIN	Tel: [+34] (91) 640 11 34	Fax: [+34] (91) 640 06 40
UK / Cambridge	Tel: [+44] (0) 1763 262277	Fax: [+44] (0) 1763 285353
*UK / Stevenage	Tel: [+44] (0) 1438 742200	Fax: [+44] (0) 1438 727601
	Freephone: 0800 282388	
*USA	Tel: [+1] (316) 522 4981	Fax: [+1] (316) 522 1360
	Toll Free: 800 835 2352	

* Indicates Regional Service Center

EXPORT CONTROL WARNING: This document contains controlled technology or technical data under the jurisdiction of the Export Administration Regulations (EAR), 15 CFR 730-774. It cannot be transferred to any foreign third party without the specific prior approval of the U.S. Department of Commerce, Bureau of Industry and Security (BIS). Violations of these regulations are punishable by fine, imprisonment, or both.

DIR #: 10000008949 AD



6107 B0



Our passion for performance is defined by three attributes represented by these three icons: solution-minded, performance-driven, customer-focused.